



HAVELLS

LV Switchgear Controlgear & Power Quality Products



Pricelist w.e.f. 1st March, 2023

Effective from 1st March, 2023

List Price (L.P.) are in Indian ₹ & as per Standard Terms & Conditions

CONTENTS

Controlgear

3 Pole Power Contactors _____	10
4 Pole, 2 Pole Power Contactors & Control Relay _____	12
Capacitor Duty Contactors _____	13
Spares & Accessories - HGS _____	14
MPCB & Accessories - HGSM _____	16
Thermal Overload Relay - HGST _____	17
Industrial Starter - HGS _____	21
Street Light Panel _____	24
Agri Starter - DOL, DOL Submersible & ASD Submersible Starter-Urja _____	26
Agri Starter - Single Phase DOL Starter, Single Phase Submersible Starter-Urja _____	27
Spares & Accessories - Urja _____	28

LV Switchgear

Titania Air Circuit Breaker _____	36
HIM Moulded Case Circuit Breaker _____	45
Loadline Moulded Case Circuit Breaker _____	50
Loadline Microprocessor Moulded Case Circuit Breaker _____	53
Star dx Series Miniature circuit breaker (MCB) _____	57
PowerSafe Load Bank MCCB Panel Boards _____	64
Euroload Changeover Switch _____	67
Instaline / Instaprime Automatic Transfer Switch _____	67
Euroload By-Pass Changeover Switch _____	68
Euroload Switch Disconnecter _____	68
Kompact Switch Disconnecter Fuse _____	69
Busbar Chamber _____	72
Hibreak Fuse Base _____	72
HBC Fuse Link _____	73

Power Quality

APFC Panel _____	77
Capacitor Duty Contactor _____	80
IPFC Relay _____	81
Cylindrical Capacitors (MPP Type) _____	82
Square Cap Capacitors (MPP Type) _____	83
Single Phase Capacitors _____	85
Thyristor Switch _____	86
HD Harmonic Detuned Reactors _____	87
Active Harmonic Filter and Broad Band Filter _____	89
Agri Boost Capacitors _____	91

Fully Automated Plant



Industry 4.0

Make in India, for India and for rest of the World

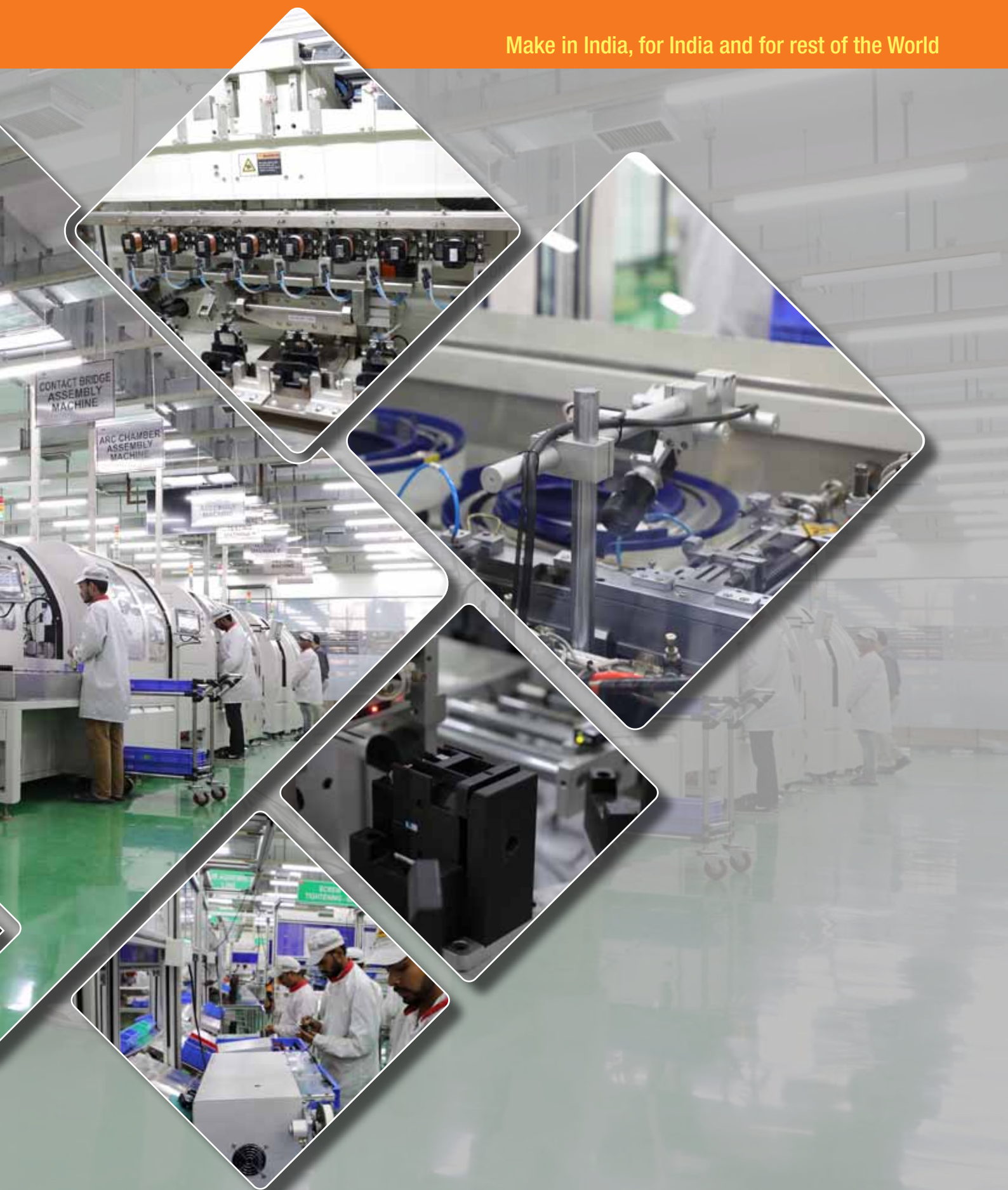

Havells Global Series

Magnetic Contactors, Overload Relays & MPCBs

Designed for demanding applications & Tropical conditions



HGS - Trusted Global Range

Contactors, Overload Relays, Starters & MPCBs

Motor Control Solutions for higher Safety, Reliability & Performance



3 Pole Contactor
Ratings - 9 A to 800 A (AC-3)



4 Pole Contactor
Ratings - 16 A to 60 A (AC-1)



2 Pole Contactor
Ratings - 9 A to 100 A (AC-3)



Capacitor Duty Contactor
Ratings - 3 kVAr to 66 kVAr

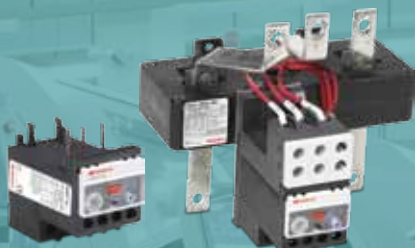

Thermal Overload Relay
Ratings - 0.12 A to 800 A



Motor Protection Circuit Breaker
Ratings - 0.1 A to 32 A



DOL Starters
Ratings - 0.55 kW to 37 kW
(0.75 HP to 50 HP)



Reversing Starters
Ratings - 1.5 kW to 15 kW
(2 HP to 20 HP)



ASD Starters
Ratings - 7.5 kW to 110 kW
(10 HP to 150 HP)



ASD 3 ϕ Submersible Starters
Ratings - 22 kW to 37 kW
(30 HP to 50 HP)



ASD 3 ϕ Submersible Starters DLX
(with Short-circuit Protection)
Ratings - 22 kW to 37 kW
(30 HP to 50 HP)



Street Light Panels
Ratings - 6 kW & 12 kW
(1 ϕ & 3 ϕ)

Contactor HGS 9 - 800 AF

3 Pole Power Contactors

Wide Operating Band Coils

Finger proof IP 20 terminals

Suitable for AC-4 (Inching & Plugging, e.g. Crane Duty) and other critical application

CE Marking & Compliance to IS/IEC 60947-4-1

High Electrical and Mechanical Durability with Higher operating frequency (Operations / Hour)

Electrical Durability Curves available

Low Power Dissipation

Low VA Burden coils with Class H Insulation

Dust free Cover as in-built

Terminal Barrier and Shrouds

Nut Retaining Washers

In-built Auxiliary Contacts

Removable Arc-chutes ≥ 115 A Ratings

DIN Channel Mounting up to 100 A, Fr-4

Contactor (HGS)



Overload Relay (HGST)



18 AF

40 AF

65 AF

100 AF

HGS

Rated Current

Rated Operational
Voltage

9 A, 12 A, 18 A
690 V

25 A, 32 A, 40 A
690 V

50 A, 65 A
690 V

75 A, 85 A, 100 A
690 V

HGST

Setting Current

0.12 A - 18 A

7 A - 40 A

7 A - 65 A

17 A - 100 A

Thermal Overload Relays HGST 9 - 800 AF



Overload Relays

Trip Class - 10A

Mounting Possibilities - Direct and Separate both

Automatic Reset or Manual Reset - Settable Button

Test Button - Can also be used as Emergency Stop Button

Phase loss Protection - Differential Tripping Mechanism (Double Slide Construction)

- Accelerated tripping on Single Phasing Condition (40% - 60% Faster)

Finger proof IP20 terminals

Sealable Protection Cover to prevent Unintended change in Protection settings



150 AF

265 AF

500 AF

800 AF

115 A, 130 A, 150 A
1000 V

185 A, 225 A, 265 A
1000 V

300 A, 400 A, 500 A
1000 V

630 A, 800 A
1000 V

48 A - 150 A

48 A - 265 A

90 A - 500 A

378 A - 800 A

Magnetic Contactor

3 Pole Power Contactors

AC Coil up to Frame-4 and AC/DC Universal coil with SMART ECM
(Electronic Control Module) in-built for Frame-5 to Frame-8

HSN Code: 8536

Frame Size	AC-3 Duty Rating at 415 V, 50 Hz	AC-1 Duty Rating at 415 V, 50 Hz	Power Poles	In-built Auxilliary Contacts		Type	Item Code	Per Unit LP (₹)
	I _e A	I _{th} A		NO	NC			
1	9 A	25 A	3	1	0	HGS 9	IHPHA009110*	1033.00
	9 A	25 A	3	0	1	HGS 9	IHPHA009101*	1033.00
	12 A	30 A	3	1	0	HGS 12	IHPHA012110*	1203.00
	12 A	30 A	3	0	1	HGS 12	IHPHA012101*	1203.00
	18 A	40 A	3	1	0	HGS 18	IHPHA018110*	1392.00
	18 A	40 A	3	0	1	HGS 18	IHPHA018101*	1392.00
	22 A	40 A	3	1	0	HGS 22	IHPHA022110*	1500.00
	22 A	40 A	3	0	1	HGS 22	IHPHA022101*	1500.00
2	25 A	45 A	3	1	0	HGS 25	IHPHA025210*	1747.00
	25 A	45 A	3	0	1	HGS 25	IHPHA025201*	1747.00
	32 A	55 A	3	1	0	HGS 32	IHPHA032210*	3683.00
	32 A	55 A	3	0	1	HGS 32	IHPHA032201*	3683.00
	40 A	60 A	3	1	0	HGS 40	IHPHA040210*	5490.00
	40 A	60 A	3	0	1	HGS 40	IHPHA040201*	5490.00
3	50 A	70 A	3	2	2	HGS 50	IHPHA050300*	7419.00
	65 A	85 A	3	2	2	HGS 65	IHPHA065300*	9288.00
4	75 A	110 A	3	2	2	HGS 75	IHPHA075400*	11121.00
	85 A	125 A	3	2	2	HGS 85	IHPHA085400*	13109.00
	100 A	135 A	3	2	2	HGS 100	IHPHA100400*	18898.00
5	115 A	160 A	3	2	2	HGS 115	IHPHA115500*	23745.00
	130 A	180 A	3	2	2	HGS 130	IHPHA130500*	24445.00
	150 A	210 A	3	2	2	HGS 150	IHPHA150500*	29796.00
6	185 A	275 A	3	2	2	HGS 185	IHPHA185600*	34460.00
	225 A	315 A	3	2	2	HGS 225	IHPHA225600*	37456.00
	265 A	350 A	3	2	2	HGS 265	IHPHA265600*	42159.00
7	300 A	400 A	3	2	2	HGS 300	IHPHA300700*	51775.00
	400 A	500 A	3	2	2	HGS 400	IHPHA400700*	64740.00
	500 A	550 A	3	2	2	HGS 500	IHPHA500700*	93264.00
8	630 A	750 A	3	2	2	HGS 630	IHPHA630800*	145498.00
	800 A	900 A	3	2	2	HGS 800	IHPHA800800*	234753.00



NEW

NEW



*To complete the Cat no. suffix the coil voltage from the coil voltage table

- Note:
1. For additional aux. contacts front/side mounted and mechanical interlock - refer accessories table.
 2. Standard Spare coil are available on request.

Coil Voltage Selection Table

Frame Size	AC Coil Codes for Nominal Voltage at 50/60 Hz					
	B	H	N	T	Wide Band Coils	
					S	W
1	24 V	110 V	240 V	415 V	150 V-300 V	260 V-440 V
2	24 V	110 V	240 V	415 V	150 V-300 V	260 V-440 V
3	24 V	110 V	240 V	415 V		260 V-440 V
4	24 V	110 V	240 V	415 V		260 V-440 V



Type of Coil	AC/DC Universal Coil with in-built ECM* Module	AC Coil with in-built ECM* Module
Nominal volatge	240 V	415 V
Frame Size / Coil Codes	N	T
5	100 V ac -240 V ac 110 V dc -220 V dc	380 V ac - 450 V ac
6	100 V ac -240 V ac 110 V dc -220 V dc	380 V ac - 450 V ac
7	100 V ac -240 V ac 110 V dc -220 V dc	380 V ac - 450 V ac
8	200 V ac -240 V ac 200 V dc -200 V dc	380 V ac - 450 V ac



ECM* - Electronic Control Module

Note :

For other coil voltages, Contact to nearest branch

To avoid Coil burning due to Neutral Floaring conditions, either use Wide band Coils or make use of 415 V Coils (If feasible)



Magnetic Contactor

4 Pole Power Contactors with AC Coil

Features:

- AC-1 Ratings up to 60 A - AC1
- Conforms to IS / IEC 60947-4-1
- Common Accessories with HGS Range
- Finger proof IP20 terminals
- Completely Shield for dusty atmosphere
- **Low VA Burden Wide operating band coils with Class H Insulation**

Frame Size	AC 1 Duty	Power Poles	Item Code	Per Unit LP (₹)	Power Poles	Item Code	Per Unit LP (₹)
1	16	4NO	IHPHC016100*	1237.00	2NO + 2NC	IHPHC016122*	1362.00
	20	4NO	IHPHC020100*	1264.00	2NO + 2NC	IHPHC020122*	1392.00
	25	4NO	IHPHC025100*	1364.00	2NO + 2NC	IHPHC025122*	1545.00
	32	4NO	IHPHC032100*	1399.00	2NO + 2NC	IHPHC032122*	1601.00
	40	4NO	IHPHC040100*	2111.00	2NO + 2NC	IHPHC040122*	2279.00
2	50	4NO	IHPHC050200*	2756.00	2NO + 2NC	IHPHC050222*	3088.00
	60	4NO	IHPHC060200*	5256.00	2NO + 2NC	IHPHC060222*	5892.00



*To complete the Cat no. suffix the coil voltage from the coil voltage table

Magnetic Contactor

Aux Contactor / Control Relay - HGS Series with AC Coil

Features:

- Common Accessories with HGS Range
- Suitable for use upto 690 V AC
- Compliance to IEC 60947-5-1
- High Thermal current of $I_{th} = 16$ A
- Finger proof IP20 terminals
- **Low VA Burden Wide operating band coils with Class H Insulation**

Frame size	I _{th}	Contact arrangement		Type	Item Code	Per Unit LP (₹) with AC Coil
		NO	NC			
1	16 A	2	2	HGR 22	IHHAC22*	995.00
		3	1	HGR 31	IHHAC31*	995.00
		4	0	HGR 40	IHHAC40*	995.00
		0	4	HGR 04	IHHAC04*	995.00
		1	3	HGR 13	IHHAC13*	995.00

*To complete the Cat no. suffix the coil voltage from the coil voltage table

Magnetic Contactor

HGS 2 Pole Contactor with AC Coil

Frame Size	Material	Material description	Per Unit LP (₹)
1	IHPHF009100*	9A 2P HGS Contactor	775.00
	IHPHF012100*	12A 2P HGS Contactor	903.00
	IHPHF018100*	18A 2P HGS Contactor	1044.00
2	IHPHF025200*	25A 2P HGS Contactor	1223.00
	IHPHF032200*	32A 2P HGS Contactor	2579.00
	IHPHF040200*	40A 2P HGS Contactor	3843.00

Magnetic Contactor

Capacitor Duty Contactor

Features:

- Range : 3 kVAr to 66 kVAr
- **De-latching Type design of Resistor Switching Block**
- Low VA Burden Wide operating band coils with Class H Insulation
- Common accessories with HGS Range
- **High Operating Frequency - 240 Operations per hour**
- Handle high inrush current capability
- Utilization category AC-6b
- Finger proof IP20 terminals

Frame Size	kVAr Rating AC-6b	Inst. Aux. Contact		Item Code	Per Unit LP (₹)
	415 V / 440 V	NO	NC		
1	3 kVAr	1	0	IHPHE003110*	2155.00
	3 kVAr	0	1	IHPHE003101*	2155.00
	5 kVAr	1	0	IHPHE005110*	2261.00
	5 kVAr	0	1	IHPHE005101*	2261.00
	10 kVAr	1	0	IHPHE010110*	2738.00
	10 kVAr	0	1	IHPHE010101*	2738.00
	12.5 kVAr	1	0	IHPHE12X110*	3093.00
	12.5 kVAr	0	1	IHPHE12X101*	3093.00
	15 kVAr	1	0	IHPHE015110*	3787.00
	15 kVAr	0	1	IHPHE015101*	3787.00
2	20 kVAr	1	0	IHPHE020210*	4163.00
	20 kVAr	0	1	IHPHE020201*	4163.00
	25 kVAr	1	0	IHPHE025210*	4748.00
	25 kVAr	0	1	IHPHE025201*	4748.00
3	33.3 kVAr	1	0	IHPHE33X210*	6882.00
	33.3 kVAr	0	1	IHPHE33X201*	6882.00
	33.3 kVAr	1	1	IHPHE33X311*	8300.00
	40 kVAr	2	2	IHPHE040322*	12757.00
4	50 kVAr	2	2	IHPHE050422*	13272.00
	66 kVAr	2	2	IHPHE066422*	15575.00

*To complete the Cat no. suffix the coil voltage from the coil voltage table

NEW 33.3 kVAr contactor in Frame-3 can be used where higher terminal capacity is required.

Description	Configuraton	Suitable for	Type	Item Code	Per Unit LP (₹)
Aux Contact Block (Side Mounting)	1NO + 1NC	HGS 9-HGS 40 (For all contactors in Frame-1 and Frame-2)	HGS SB	ISSPCU1969	645.00
		HGS50-HGS 100 (For all contactors in Frame-3 and Frame-4)		ISSPCU1970	
		HGS115- HGS 800		ISSPCU1971	763.00
Aux Contact Block (Top Mounting)	2NC	HGS9-HGS100 (For all contactors in Frame-1 to Frame-4)	HGS TB	ISSPCU1961	403.00
	1NO + 1NC			ISSPCU1962	
	2NO			ISSPCU1963	
	4NC			ISSPCU1964	666.00
	1NO + 3NC			ISSPCU1965	
	2NO + 2NC			ISSPCU1966	
	3NO + 1NC			ISSPCU1967	
	4NO			ISSPCU1968	
Mechanical Interlock Unit		HGS 9-HGS 40 # (For all contactors in Frame-1 and Frame-2)	HGS MIU	ISSPCU1972	874.00
		HGS50-HGS 100 (For all contactors in Frame-3 and Frame-4)		ISSPCU1973	2053.00
		HGS115- HGS 265		ISSPCU1974	3632.00
		HGS 300- HGS 800		ISSPCU1975	4118.00
Mechanical Latching Block (Top Mounting)	220 V AC	HGS 9-HGS 100 (For all contactors in Frame-1 to Frame-4)	HGS MLB	ISSPCU1976	2059.00
Electronic Timer (Top Mounting)		HGS 9-HGS 100 (For all contactors in Frame-1 to Frame-4)	HGS ET	ISSPCU1977	2783.00
Surge Absorber* (Surge Suppressor Type RC)	220 V - 240 V AC	HGS 9-HGS 100 (For all contactors in Frame-1 to Frame-4)	HGS SA	ISSPCU1984	1755.00



- One contactor of Frame-1 and another contactor of Frame-2 can also be interlocked using this Mechanical Interlock Unit.

*Contact to nearest branch

- For other voltages in RC type surge suppressors

- For other type of surge suppressors



Spare Coils - HGS Contactors

(Refer Frame Sizes in Respective Contactor Table)

Suitable for	Coil Type	Voltage	Item Code	Per Unit LP (₹)
For all Frame-1 Contactors (HGS 9 to HGS 22)	AC	24 V	ISSPCU1985	541.00
		110 V	ISSPCU1987	
		240 V	ISSPCU1989	
		415 V	ISSPCU2050	
		150 V-300 V	ISSPCU2215	
		260 V-440 V	ISSPCU2134	
For all Frame-2 Contactors (HGS 25-HGS 40)	AC	24 V	ISSPCU1993	541.00
		110 V	ISSPCU1995	
		240 V	ISSPCU1997	
		415 V	ISSPCU2053	
		150 V-300 V	ISSPCU2216	
		260 V-440 V	ISSPCU2135	
For all Frame-3 Contactors (HGS 50-HGS 65)	AC	24 V	ISSPCU2001	1765.00
		110 V	ISSPCU2003	
		240 V	ISSPCU2005	
		415 V	ISSPCU2007	
		260 V-440 V	ISSPCU2136	
For all Frame-4 Contactors (HGS 75-HGS 100)	AC	24 V	ISSPCU2009	2032.00
		110 V	ISSPCU2011	
		240 V	ISSPCU2013	
		415 V	ISSPCU2015	
		260 V-440 V	ISSPCU2137	
For Frame-5 Contactors (HGS 115-HGS 150)	AC/DC Universal Coil	100 Vac-240 Vac 110 Vdc -220 Vdc	ISSPCU1979	5500.00
	AC	380 Vac-450 Vac	On Request	
For Frame-6 Contactors (HGS 185-HGS 265)	AC/DC Universal Coil	100 Vac-240 Vac 110 Vdc -220 Vdc	ISSPCU1980	7788.00
	AC	380 Vac-450 Vac	ISSPCU2312	
For Frame-7 Contactors (HGS 300-HGS 500)	AC/DC Universal Coil	100 Vac-240 Vac 110 Vdc -220 Vdc	ISSPCU1981	10127.00
	AC	380 Vac-450 Vac	ISSPCU2103	
For Frame-8 Contactors (HGS 630-HGS 800)	AC/DC Universal	110 Vac-127 Vac 100 Vdc -110 Vdc	On Request	20765.00
		200 Vac-240 Vac 200 Vdc -220 Vdc	ISSPCU1982	
	AC	380 Vac-450 Vac	ISSPCU2104	



MPCB specially coordinated for IE2, IE3 & IE4 Motors

MPCB Motor Protection Circuit Breaker - HGSM Series



Push Button Version*

Features:

- 1 Frame size - 45 mm width
- High Magnetic Setting - Makes it suitable for IE2, IE3 and IE4 Motors
- Tripping class: 10 A
- Mechanical Life: 100000 cycles
- Electrical Life: 100000 cycles
- Compliance to IEC 60947-2, IEC 60947-4-1
- In-built "Type-2 Co-ordination"
- Finger proof IP20 Terminals
- Lockable in OFF Position

* - For Rotary type MPCB, Contact to nearest branch

Item Code	Item Description	Per Unit LP (₹)
IHHMPBA2A0	MPCB HGSM 0.1 A - 0.16 A 100 kA	2588.00
IHHMPBB2B0	MPCB HGSM 0.16 A - 0.25 A 100 kA	
IHHMPBC2D0	MPCB HGSM 0.25 A - 0.4 A 100 kA	
IHHMPBD2E0	MPCB HGSM 0.4 A - 0.63 A 100 kA	2934.00
IHHMPBE2F0	MPCB HGSM 0.63 A - 1 A 100 kA	
IHHMPBF2G0	MPCB HGSM 1 A - 1.6 A 100 kA	2957.00
IHHMPBG2R0	MPCB HGSM 1.6 A - 2.5 A 100 kA	
IHHMPBH2I0	MPCB HGSM 2.5 A - 4 A 100 kA	3063.00
IHHMPBJ2J0	MPCB HGSM 4 A - 6.3 A 100 kA	
IHHMPBK2K0	MPCB HGSM 6.3 A - 10 A 100 kA	3275.00
IHHMPBL2L0	MPCB HGSM 9 A - 14 A 15 kA	
IHHMPBN2M0	MPCB HGSM 13 A - 18 A 15 kA	4200.00
IHHMPBQ2T0	MPCB HGSM 17 A - 23 A 15 kA	
IHHMPBS2N0	MPCB HGSM 20 A - 25 A 15 kA	4418.00
IHHMPBT2P0	MPCB HGSM 24 A - 32 A 10 kA	

Item Code	Item Description	Per Unit LP (₹)
ISSPCU2406	UV Release MPCB HGSM 110VAC 50Hz	1927.00
ISSPCU2407	UV Release MPCB HGSM 240VAC 50Hz	
ISSPCU2408	UV Release MPCB HGSM 415VAC 50Hz	
ISSPCU2409	Shunt release MPCB HGSM 110VAC 50Hz	
ISSPCU2410	Shunt release MPCB HGSM 240VAC 50Hz	
ISSPCU2411	Shunt release MPCB HGSM 415VAC 50Hz	693.00
ISSPCU2412	Aux block top mount 2NO MPCB HGSM	
ISSPCU2413	Aux block top mount 1NO1NC MPCB HGSM	
ISSPCU2414	Aux block Side mount 2NO MPCB HGSM	956.00
ISSPCU2415	Aux block Side mount 1NO1NC MPCB HGSM	
ISSPCU2416	Fault alarm Aux 1NC 1NO MPCB HGSM	1392.00
ISSPCU2417	Fault alarm Aux 1NC 1NC MPCB HGSM	
ISSPCU2418	Fault alarm Aux 1NO 1NO MPCB HGSM	
ISSPCU2419	Box waterproof IP55 MPCB HGSM	1444.00
ISSPCU2420	Emergency Box waterproof IP55 MPCB HGSM	





Thermal Over Load Relay (Auto/ Manual Reset)

Features:

- Range : 0.12 A – 800 A available in 8 Frames, Trip class - 10 A
- Conforms to IS/IEC 60947-4-1
- Protection against overload & phase loss protection
- Auto / manual reset facility
- Contactor mounting / Individual mounting with adaptor
- Transparent protection cover for dust application

HSN Code: 8536

Relay Frame size	Relay Range (A)	Suitable for Contactor Frame size	Type	Item Code	Per Unit LP (₹)
1	0.12 A - 0.18 A	HGS 9 HGS 12 HGS 18 HGS 22	HGST18	IHHR13CA	1760.00
	0.18 A - 0.26 A			IHHR13CB	
	0.25 A - 0.35 A			IHHR13CC	
	0.34 A - 0.5 A			IHHR13CD	
	0.5 A - 0.7 A			IHHR13CE	
	0.6 A - 0.9 A			IHHR13CF	
	0.8 A - 1.2 A			IHHR13CG	
	1.1 A - 1.6 A			IHHR13CH	
	1.5 A - 2.1 A			IHHR13CJ	
	2 A - 3 A			IHHR13CZ	
	2.8 A - 4.2 A			IHHR13CK	
	3 A - 5 A			IHHR13CL	
	4 A - 6 A			IHHR13CM	
	5.6 A - 8 A			IHHR13CN	
	6 A - 9 A			IHHR13CP	
	8 A - 12 A			IHHR13CR	1791.00
12 A - 18 A	IHHR13CT	1966.00			



Thermal Over Load Relay - HGST Series

Relay Frame size	Relay Range (A)	Suitable for Contactor Frame size	Type	Item Code	Per Unit LP (₹)
2	7 A - 10.0 A	HGS 25 HGS 32 HGS 40	HGST 40	IHHR23CQ	1966.00
	8 A - 12.0 A			IHHR23CR	
	12 A - 18 A			IHHR23CT	
	15 A - 22 A			IHHR23CU	
	17 A - 25 A			IHHR23CV	
	22 A - 32 A			IHHR23CW	
	28 A - 40 A			IHHR23CX	
3	7 A - 10.0 A	HGS 50 HGS 65	HGST 65	IHHR33CQ	3446.00
	8 A - 12.0 A			IHHR33CR	
	12 A - 18 A			IHHR33CT	
	15 A - 22 A			IHHR33CU	
	17 A - 25 A			IHHR33CV	
	22 A - 32 A			IHHR33CW	
	28 A - 40 A			IHHR33CX	
	34 A - 50 A			IHHR33CY	
	45 A - 65 A			IHHR33C1	
4	17 A - 25 A	HGS 75 HGS 85 HGS 100	HGST 100	IHHR43CV	4000.00
	22 A - 32 A			IHHR43CW	
	28 A - 40 A			IHHR43CX	
	34 A - 50 A			IHHR43CY	
	45 A - 65 A			IHHR43C1	
	52 A - 75 A			IHHR43C2	
	59 A - 85 A			IHHR43C3	
	70 A - 100 A			IHHR43C4	
5	48 A - 80 A	HGS 115 HGS 130 HGS 150	HGST 150	IHHR53C5	8444.00
	69 A - 115 A			IHHR53C6	
	78 A - 130 A			IHHR53C7	
	90 A - 150 A			IHHR53C8	
6	48 A - 80 A	HGS 185 HGS 225 HGS 265	HGST 265	IHHR63C5	9074.00
	69 A - 115 A			IHHR63C6	
	78 A - 130 A			IHHR63C7	
	90 A - 150 A			IHHR63C8	
	111 A - 185 A			IHHR63C9	
	135 A - 225 A			IHHR63C11	
	159 A - 265 A			IHHR63C12	
7	90 A - 150 A	HGS 300 HGS 400 HGS 500	HGST 500	IHHR73C8	11024.00
	111 A - 185 A			IHHR73C9	
	135 A - 225 A			IHHR73C11	
	159 A - 265 A			IHHR73C12	
	180 A - 300 A			IHHR73C13	
	240 A - 400 A			IHHR73C14	
	300 A - 500 A			IHHR73C15	
8	378 A - 630 A	HGS 630 HGS 800	HGST 800	IHHR83C16	30193.00
	480 A - 800 A			IHHR83C17	



Tougher & Trusted

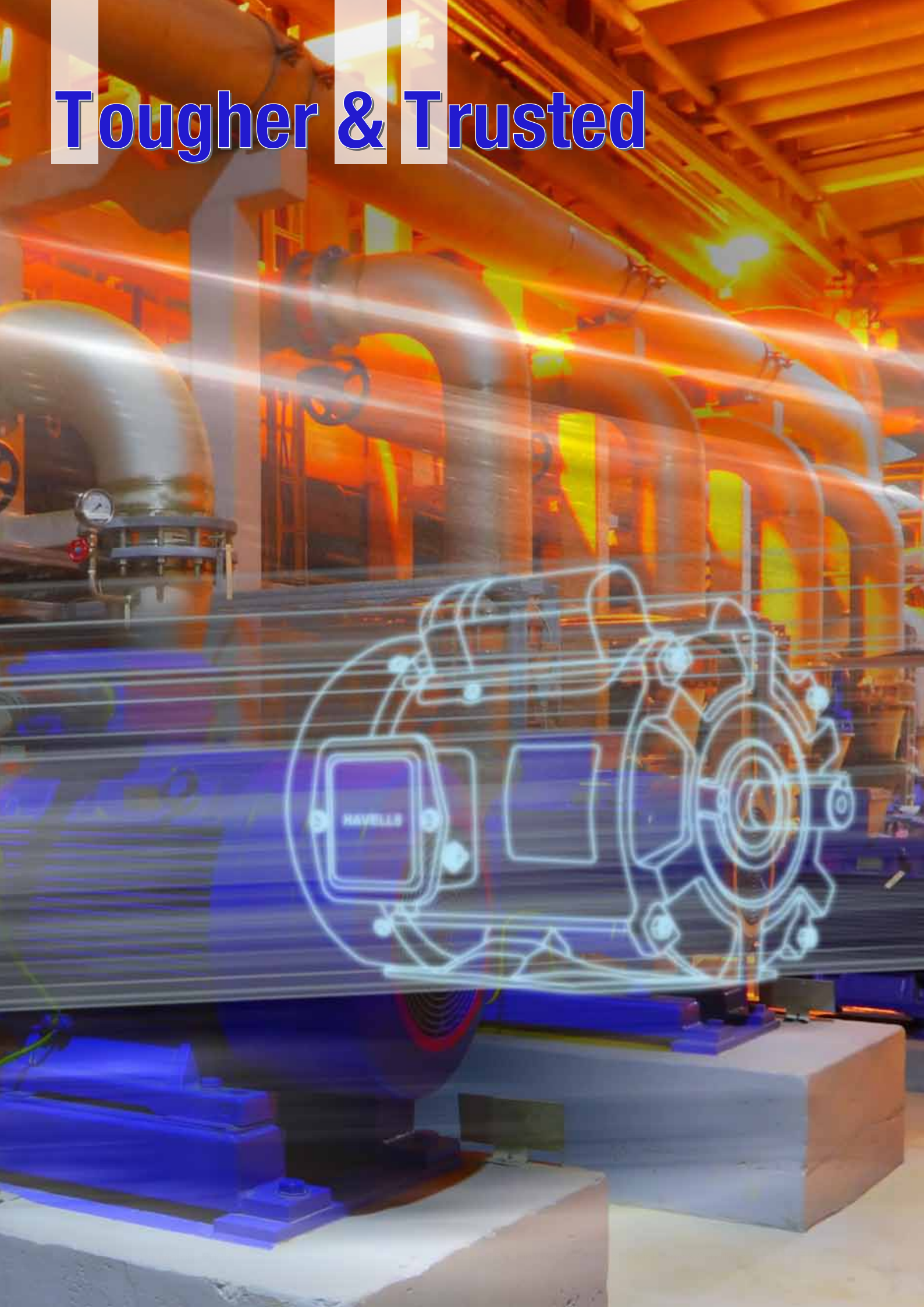

HGS - Starter Range

(Complete range with HGST Overload Relay)



Range:

- Direct Online Starter - 0.55 kW to 37 kW (0.75 HP to 50 HP)
- Fully Automatic Star - Delta Starter (ASD) 7.5 kW to 110 kW (10 HP to 150 HP)
- Reversing Starter - 1.5 kW to 15 kW (2 HP to 20 HP)
- Standard Automatic Star Delta Submersible Pump Starter - 22 kW to 37 kW (30 HP to 50 HP)
- Automatic Star Delta Submersible Pump Starter DLX - 22 kW to 37 kW (30 HP to 50 HP)

Features & Benefits (HGS Motor Starter)

Single Phasing Protection: HGST relays have in-built single phase failure protection. A very sensitive tripping mechanism provides reliable protection against single phasing & overload conditions. HGST relays are compensated for variation in ambient temperature.

IP 54 degree of protection: Corrosion resistant powder coated enclosure with IP 54 protection class makes HGS starters most suitable in all climatic conditions.

Stop & Test Facility: This type of dual facility enables the user to stop the motor operation during emergency by pressing the test button which will open the contacts and will stop the motor.

To test the contact operation of the thermal overload relay, the test button can be pulled up to change the contact status for prompt testing. The voltage supplied for the power consumption of the coil, capacitance of control circuit and others need to be reviewed to apply an appropriate conductor length within the limit.

Trip mechanisms: These thermal overload relays are provided with built-in manual tripping mechanisms so that they can be manually trip without supplying power to the main circuit. The relay will trip in case of overloads or single phasing conditions and can be seen by Yellow flag for trip indication.

Protection Cover: The front of the HGST Relay operating side is covered with a transparent protection cover so that the current value setting and reset operating method cannot be changed arbitrarily.

To change the setting, lift the transparent cover up.

Reset Button / Selector: Using a driver reset mode can be set. In Manual mode (H) push the button to reset the relay and while changing the relay to Automatic mode (A) from Manual mode resetting will be done automatically.

Separation of reset button and test button - Prevents malfunction

Ease of Maintenance: Contactor & Overload Relay mounted on base plate, easily removable for maintenance if required.

Specification: Confirms to IS / IEC 60947-4-1

Direct Online Starter - HGS Series

Features:

- Range : 0.6 kW to 37.3 kW (0.75 HP to 50 HP)
- Conforms to IS/IEC 60947-4-1
- Provided with Protection Degree IP 54
- Extended wide band coil
- FRLS (Fire retardant low smoke) Internal wiring
- Starter Type - Air Break
- Class H Insulation

HSN Code: 8536

HP	kW	Contactor Rating	Overload Relay Range (A)	Item Code	Per Unit LP (₹)
0.75 HP	0.55 kW	12	1.5 A - 2.1 A	IHHDOLFA*E	3412.00
1 HP	0.75 kW	12	2 A - 3 A	IHHDOLGA*E	
2 HP	1.5 kW	12	2.8 A - 4.2 A	IHHDOLHA*E	
3 HP	2.2 kW	12	4.0 A - 6.0 A	IHHDOLJA*E	
5 HP	3.7 kW	12	6 A - 9 A	IHHDOLLA*E	
7.5 HP	5.5 kW	18	12 A - 18 A	IHHDOLMA*E	
10 HP	7.5 kW	22	12 A - 18 A	IHHDOLNA*E	4096.00
15 HP	11 kW	32	17 A - 25 A	IHHDOLPB*E	6614.00
20 HP	15 kW	32	22 A - 32 A	IHHDOLWB*	10642.00
25 HP	18.5 kW	40	28 A - 40 A	IHHDOLXB*	17614.00
30 HP	22 kW	50	34 A - 50 A	IHHDOLYC*	18592.00
40 HP	30 kW	65	45 A - 65 A	IHHDOL1C*	20642.00
50 HP	37 kW	85	59 A - 85 A	IHHDOL3D*	23938.00



AC Coil

Code*	T	W
AC Voltage	415 V	260 V - 440 V

Fully Automatic Star-Delta Starter (ASD) - HGS Series

Features:

- Range : 7.5 kW to 110 kW (10 HP to 150 HP)
- Conforms to IS/IEC 60947-4-1
- Provided with Protection Degree IP 54
- Extended wide band coil
- FRLS (Fire retardant low smoke) Internal wiring
- Starter Type - Air Break
- Class H Insulation

HSN Code: 8536

HP	kW	Contactor Size	Overload Relay Range (A)	Item Code	Per Unit LP (₹)
10 HP	7.5 kW	18	8.0 A - 12 A	IHHASDRA*	12377.00
12.5 HP	9.3 kW	18	8.0 A - 12 A	IHHASDTA*	12546.00
15 HP	11 kW	25	12 A - 18.0 A	IHHASDTB*	12602.00
20 HP	15 kW	25	15 A - 22 A	IHHASDUB*	13221.00
25 HP	18.5 kW	32	17 A - 25 A	IHHASDVB*	15963.00
30 HP	22 kW	32	22 A - 32 A	IHHASDWB*	17417.00
35 HP	26 kW	32	28 A - 40 A	IHHASDXB*	25853.00
50 HP	37 kW	50	34 A - 50 A	IHHASDYC*	44143.00
60 HP	45 kW	50	45 A - 65 A	IHHASD1C*A	64778.00
75 HP	55 kW	65	45 A - 65 A	IHHASD1C*B	71256.00
90 HP	67.5 kW	85	59 A - 85 A	IHHASD3D*	83400.00
100 HP	75 kW	100	70 A - 100 A	IHHASD4D*	87503.00
125 HP	90 kW	115	78 A - 130 A	IHHASD7E*	120544.00
150 HP	110 kW	150	90 A - 150 A	IHHASD8E*	122278.00



AC Coil

Code*	T	W
AC Voltage	415 V	260 V - 440 V

- Starters are supplied with standard coil voltage 415 Vac
- For other voltages please specify coil code from the below table. (*suffix code)

Reversing Starter - HGS Starter

Features:

- Range : 1.5 kW to 14.9 kW (2 HP to 20 HP)
- Conforms to IS/IEC 60947-4-1
- Provided with Protection Degree IP 54
- Extended wide band coil
- FRLS (Fire retardant low smoke) Internal wiring
- Starter Type - Air Break
- Class H Insulation

HSN Code: 8536

HP	kW	Contactors Size	Overload Relay Range (A)	Item Code	Per Unit LP (₹)
2 HP	1.5 kW	18	2.8 A - 4.2 A	IHHREVKA*	11774.00
3 HP	2.2 kW	18	4.0 A - 6.0 A	IHHREVMA*	
5 HP	3.7 kW	18	6.0 A - 9.0 A	IHHREVPA*	
7.5 HP	5.5 kW	18	8.0 A - 12 A	IHHREVRA*	
10 HP	7.5 kW	18	12 A - 18.0 A	IHHREVT*	
15 HP	11 kW	32	17 A - 25 A	IHHREVVB*	15914.00
20 HP	15 kW	32	28 A - 40 A	IHHREVXB*	23870.00



AC Coil

Code*	T	W
AC Voltage	415 V	260 V - 440 V

Automatic Star Delta Submersible Starter (Standard) - HGS Series

Features:

- Range : 22.4 kW to 37.5 kW (30 HP to 50 HP)
- Conforms to IS/IEC 60947-4-1
- Provided with Protection Degree IP 54
- Extended wide band coil
- FRLS (Fire retardant low smoke) Internal wiring
- In-built metering
- Class H Insulation

HSN Code: 8536

HP	kW	Full load Line Current	Full Load phase current	Contactors Size	Overload Relay Range (A)	Item Code	Per Unit LP (₹)
30 HP	22 kW	43.5	25.12	50	28 A - 40 A	IHHSSDXC*	36040.00
35 HP	26 kW	50.75	29.30	50	34 A - 50 A	IHHSSDYC*A	38188.00
40 HP	30 kW	58	33.49	65	34 A - 50 A	IHHSSDYC*B	42002.00
45 HP	33.6 kW	65.25	37.67	75	45 A - 65 A	IHHSSD1D*	52506.00
50 HP	37 kW	72.5	41.86	85	52 A - 75 A	IHHSSD2D*	57274.00



Automatic Star Delta Submersible Starter DLX (with short-circuit Protection) - HGS Series

Features:

- Range : 22.4 kW to 37.5 kW (30 HP to 50 HP)
- Conforms to IS/IEC 60947-4-1
- Provided with Protection Degree IP 54
- Extended wide band coil
- FRLS (Fire retardant low smoke) Internal wiring
- In-built metering & MCB
- Class H Insulation

HSN Code: 8536

HP	kW	Full load Line Current	Full Load phase current	Contactors Size	Overload Relay Range (A)	TP MCB Rating (A)	Item Code	Per Unit LP (₹)
30 HP	22 kW	43.5	25.12	50	28 A - 40 A	100 A	IHHSDXC*	37076.00
35 HP	26 kW	50.75	29.30	50	34 A - 50 A	100 A	IHHSDYC*A	39265.00
40 HP	30 kW	58	33.49	65	34 A - 50 A	100 A	IHHSDYC*B	43151.00
45 HP	33.6 kW	65.25	37.67	75	45 A - 65 A	125 A	IHHSD1D*	53855.00
50 HP	37 kW	72.5	41.86	85	52 A - 75 A	125 A	IHHSD2D*	58714.00













AC Coil

Code*	T	W
AC Voltage	415 V	260 V - 440 V

Spares for Motor Starter - HGS Series

HSN Code: 8538

Type	Item Code	Per Unit LP (₹)		
Start Push Button - Green	ICELL00002	174.00		Start Push Button
Stop Push Button - Red	ICELL00003			Stop Push Button
Motor ON Indicating Light-Green	ICELKL00015	283.00		Motor ON Indicating
Motor Trip Indicating Light-Yellow	ICELKL00013			Motor Trip Indicating
SPP	ISCELXL00063	2984.00		SPP
Combined Voltmeter & Ammeter	ISCELMX0007	1165.00		AV Meter
Terminal Block 6 way	ICELPSMX001	435.00		TB 6 Way
Terminal Block 3 way	ICELPSMX002	262.00		TB 3 Way
VOLT.SEL SW. C/G	ICELQL00021	406.00		Volt Sel Switch
Timer	ICELRPSL005	2571.00		Timer
Mini Rocker Switch - SPP By Pass	ISCELEL00218	43.00		Mini Rocker Switch

Street Light Panel



HGS Smarty Series

Features:

- Range : 6 kW to 12 kW
- Conforms to IS/IEC 60947-4-1
- Provided with Protection Degree IP 54
- Extended wide band coil
- FRLS (Fire retardant low smoke) Internal wiring
- In-built Short-Circuit Protection
- Class H Insulation

HSN Code: 8537

Phase	Frame Size	Max. Load (kW)	Time Switch	Contactor Rating (A)	MCB Rating	Item Code	Per Unit LP (₹)
3	1	6 kW	Digital 24 hour	32 A TP	40 A TPN	IHXTS03060	31295.00
	1	6 kW	Astronomical	32 A TP	40 A TPN	IHXTS0306A	
	2	12 kW	Digital 24 hour	65 A TP	63 A TPN	IHXTS09120	48289.00
	2	12 kW	Astronomical	65 A TP	63 A TPN	IHXTS0912A	
1	1	6 kW	Digital 24 hour	32 A TP	40 A SPN	IHXSS01060	23465.00
	1	6 kW	Astronomical	32 A TP	40 A SPN	IHXSS0106A	
	1	12 kW	Digital 24 hour	65 A TP	63 A SPN	IHXSS03120	35260.00
	1	12 kW	Astronomical	65 A TP	63 A SPN	IHXSS0312A	

Description	Item Code	Per Unit LP (₹)
PROGRAMMABLE TIME SWITCH FOR SLP	IHXTS03060	3399.00
ASTRONOMICAL TIME SWITCH FOR SLP	IHXTS0306A	3674.00

For customised Street Lighting Panels, contact to nearest branch

Agricultural Motor Starter



1 ϕ DOL Starters
Ratings - 0.37 kW to 2.2 kW
(0.5 HP to 3 HP)



3 ϕ DOL Starters
Ratings - 0.55 kW to 11 kW
(0.75 HP to 15 HP)



1 ϕ Submersible Starters with Start & Run Capacitor
Ratings - 0.37 kW to 2.2 kW
(0.5 HP to 3 HP)



3 ϕ DOL Submersible Starters
Ratings - 0.75 kW to 11 kW
(1 HP to 15 HP)



3 ϕ ASD Submersible Starters
Ratings - 3.7 kW to 15 kW
(5 HP to 20 HP)

Motor Starter

Features:

- Range : 0.56 kW to 11 kW (0.75 HP to 15 HP)
- Conforms to IS/IEC 60947-4-1
- Provided with Protection Degree IP 54
- Extended wide band coil
- FRLS (Fire retardant low smoke) Internal wiring
- Starter Type - Air Break
- Class H Insulation

Direct Online Starter - (Ideal for Agri Pump Application) HSN Code: 8536

HP	kW	Contactor	O/L Relay	Motor Starter	
		(A)	(A)	Cat. No.	List Price in ₹ Per Unit
0.75 HP	0.55 kW	20 A	1.07 A - 1.7 A	IHADOAE1*	2895.00
1 HP	0.75 kW	20 A	1.58 A - 2.5 A	IHADOAF1*	
2 HP	1.5 kW	20 A	2.4 A - 3.8 A	IHADOAG1*	
3 HP	2.2 kW	20 A	3.8 A - 6.0 A	IHADOAH1*	
5 HP	3.7 kW	20 A	6.0 A - 9.3 A	IHADOAJ1*	
7.5 HP	5.5 kW	20 A	8.9 A - 13.5 A	IHADOAK1*	
		20 A	13.2 A - 20 A	IHADOAK1*A	
		20 A	17.4 A - 24 A	IHADOAK1*B	
10 HP	7.5 kW	25 A	13.2 A - 20 A	IHADOAL1*	3478.00
15 HP	11 kW	32 A	17.4 A - 24 A	IHADOAM1*	4094.00

*To complete the Cat no. suffix the coil voltage from the coil voltage table

AC Coil

Code*	K
AC Voltage	260 V-440 V

Direct Online Starter Submersible Pump Controller (Standard)

3 Phase - Agri Series

HSN Code: 8536

HP	kW	Max. Operational Current (A)	Contactor AC3 (A)	OLR (A)	Cat No.	List Price in ₹ Per Unit
1 HP	0.75 kW	1.90 A	20 A	1.58 A - 2.5 A	IHSDOAF1*A	9148.00
2 HP	1.5 kW	3.81 A	20 A	3.8 A - 6.0 A	IHSDOAH1*A	
3 HP	2.2 kW	5.71 A	20 A	3.8 A - 6.0 A	IHSDOAH1*B	
5 HP	3.7 kW	9.52 A	20 A	8.9 A - 13.5 A	IHSDOAK1*A	
7.5 HP	5.5 kW	14.27 A	20 A	13.2 A - 20 A	IHSDOAL1*A	9623.00
10 HP	7.5 kW	19.03 A	25 A	13.2 A - 20 A	IHSDOAL1*B	
12.5 HP	9.3 kW	23.79 A	32 A	17.4 A - 24 A	IHSDOAM1*A	
15 HP	11 kW	28.55 A	32 A	22 A - 30 A	IHSDOAN1*A	11218.00

AC Coil

Code*	K
AC Voltage	260 V - 440 V

Automatic Star Delta Submersible Pump Controller (Standard)

3 Phase - Agri Series

HSN Code: 8536

HP	Max Operating Current 135% (A)	Phase Current (A)	OLR (A)	Contactor AC3 (A)	Cat. No.	List Price in ₹ Per Unit
5 HP	10.13 A	5.85 A	3.8 A - 6.0 A	20 A	IHSASAH1*A	16069.00
7.5 HP	15.19 A	8.77 A	6 A - 9.3 A	20 A	IHSASAJ1*A	
10 HP	20.25 A	11.69 A	8.9 A - 13.5 A	20 A	IHSASAK1*A	
12.5 HP	25.31 A	14.61 A	13.2 A - 20 A	20 A	IHSASAL1*A	17465.00
15 HP	30.38 A	17.54 A	13.2 A - 20 A	20 A	IHSASAL1*B	17846.00
17.5 HP	35.44 A	20.46 A	17.4 A - 24 A	25 A	IHSASAM1*A	
20 HP	40.50 A	23.38 A	22 A - 30 A	32 A	IHSASAN1*A	20449.00

AC Coil

Code*	K
AC Voltage	260 V - 440 V



Motor Starter

Features:

- Range : 0.37 kW to 2.2 kW (0.5 HP to 3 HP)
- Conforms to IS/IEC 60947-4-1
- Provided with Protection Degree IP 54
- Extended wide band coil
- FRLS (Fire retardant low smoke) Internal wiring
- Starter type Air break
- Class H Insulation

Direct Online Starter Single Phase

HP	kW	FLC (A)	Contactor (A)	O/L Relay (A)	Cable Size mm ²		Max Backup Fuse Rating (A)	Item Code	Per Unit LP (₹)
					AL	CU			
0.5 HP	0.37 kW	3.12 A	20 A	3.8 A - 6.0 A	1.5 mm ²	1 mm ²	20 A	IHUDOLG1F1	1966.00
1 HP	0.75 kW	6.24 A	20 A	6 A - 9.3 A	1.5 mm ²	1 mm ²	25 A	IHUDOLH1F1	
1.5 HP	1.1 kW	9.15 A	20 A	8.9 A - 13.5 A	2.5 mm ²	1.5 mm ²	32 A	IHUDOLK1F1	
2 HP	1.5 kW	12.47 A	20 A	13.2 A - 20 A	4 mm ²	2.5 mm ²	50 A	IHUDOLK1FA	2020.00
3 HP	2.2 kW	18.71 A	25 A	17.4 A - 24 A	6 mm ²	4 mm ²	63 A	IHUDOLL1F1	



AC Coil

Code*	F
AC Voltage	140 V - 270 V

- Starters are supplied with standard coil voltage 415 Vac
- For other voltages please specify coil code from the below table. (*suffix code)

Submersible Pump Controller Single Phase

HSN Code: 8536

HP Rating	kW	Overload Relay (A)	Contactor (A)	Start Capacitor μ F (MFD)	Run Capacitor μ F (MFD)	Cat No.	List Price in ₹ Per Unit
0.5 HP	0.37 kW	3.8 A - 6.0 A	20 A	80 μ F - 100 μ F	25 μ F	IHADOAH1F1	4844.00
0.5 HP	0.37 kW	3.8 A - 6.0 A	20 A	80 μ F - 100 μ F	36 μ F	IHADOAJ1FA	
1 HP	0.75 kW	6 A - 9.3 A	20 A	100 μ F - 120 μ F	36 μ F	IHADOAJ1FB	
1 HP	0.75 kW	6 A - 9.3 A	20 A	100 μ F - 120 μ F	50 μ F	IHADOAJ1FC	
1 HP	0.75 kW	6 A - 9.3 A	20 A	120 μ F - 150 μ F	50 μ F	IHADOAJ1FD	
1.5 HP	1.1 kW	8.9 A - 13.5 A	20 A	120 μ F - 150 μ F	50 μ F	IHADOAK1FA	5345.00
1.5 HP	1.1 kW	8.9 A - 13.5 A	20 A	150 μ F - 200 μ F	36+36 μ F	IHADOAK1FB	
2 HP	1.5 kW	13.2 A - 20 A	20 A	150 μ F - 200 μ F	36+36 μ F	IHADOAL1FA	5715.00
2 HP	1.5 kW	13.2 A - 20 A	20 A	150 μ F - 200 μ F	50+50 μ F	IHADOAL1FB	
2 HP	1.5 kW	13.2 A - 20 A	20 A	200 μ F - 250 μ F	50+36 μ F	IHADOAL1FC	
3 HP	2.2 kW	17.4 A - 24 A	25 A	200 μ F - 250 μ F	50+50 μ F	IHADOAM1FA	6779.00
3 HP	2.2 kW	17.4 A - 24 A	25 A	200 μ F - 250 μ F	50+36+36 μ F	IHADOAM1FB	



Spares - Motor Starters & Controllers

Contactor 4 Pole & 2 Pole (20 A to 40 A)

HSN Code: 8536

AC-3 Duty Rating at 415 V, 50 Hz Ie (A)	AC-1 Duty Rating at 415 V, 50 Hz Ie (A)	Power Poles	Type	Item Code	Item Description	Per Unit LP (₹)
20 A	25 A	4	UC1 20 F	IHPBC020100*	20 A 4P Contactor	2657.00
25 A	40 A	4	UC1 25 F	IHPBC025100*	25 A 4P Contactor	3443.00
32 A	45 A	4	UC1 32 F	IHPBC032100*	32 A 4P Contactor	4195.00
40 A	63 A	4	UC1 40 F	IHPBC040100*	40 A 4P Contactor	5899.00
20 A	32 A	2	UC1 20 D	IHPBF020100*	20 A 2P Contactor	1243.00
25 A	40 A	2	UC1 25 D	IHPBF025100*	25 A 2P Contactor	1726.00
40 A	63 A	2	UC1 40 D	IHPBF040100*	40 A 2P Contactor	2324.00



*To complete the Cat no. suffix the coil voltage from the coil voltage table

AC Coil for 4 Pole

Code*	F	K
AC Voltage	140 V - 270 V	260 V - 440 V

AC Coil for 2 Pole

Code*	F
AC Voltage	140 V - 270 V

Thermal Overload Relay 3 Pole & 2 Pole

HSN Code: 8536

Relay Range (A)	Suitable for	Poles	Type	Item Code	Item Description	Per Unit LP (₹)
1.07 A - 1.7 A	4 Pole Contactors	3	UR1 E	IHAR13CE	3P Thermal O/L Relay A/M	1630.00
1.58 A - 2.5 A		3	UR1 F	IHAR13CF	3P Thermal O/L Relay A/M	
2.4 A - 3.8 A		3	UR1 G	IHAR13CG	3P Thermal O/L Relay A/M	
3.8 A - 6.0 A		3	UR1 H	IHAR13CH	3P Thermal O/L Relay A/M	
6 A - 9.3 A		3	UR1 J	IHAR13CJ	3P Thermal O/L Relay A/M	
8.9 A - 13.5 A		3	UR1 K	IHAR13CK	3P Thermal O/L Relay A/M	
13.2 A - 20 A		3	UR1 L	IHAR13CL	3P Thermal O/L Relay A/M	
17.4 A - 24 A		3	UR1 M	IHAR13CM	3P Thermal O/L Relay A/M	
22 A - 30 A		3	UR1 N	IHAR13CN	3P Thermal O/L Relay A/M	
3.8 A - 6 A	2 Pole Contactors	2	UR1 H	IHAR12CH	2P Thermal O/L Relay A/M	842.00
6 A - 9.3 A		2	UR1 J	IHAR12CJ	2P Thermal O/L Relay A/M	
8.9 A - 13.5 A		2	UR1 K	IHAR12CK	2P Thermal O/L Relay A/M	
13.2 A - 20 A		2	UR1 L	IHAR12CL	2P Thermal O/L Relay A/M	920.00
17.4 A - 24 A		2	UR1 M	IHAR12CM	2P Thermal O/L Relay A/M	
22 A - 30 A		2	UR1 N	IHAR12CN	2P Thermal O/L Relay A/M	



Spares - Motor Starters & Controllers

Spare Agri Contactor 2P / 4P

HSN Code: 8538

Type	Rating	Item Code	Per Unit LP (₹)
Housing 2P		ISCPMPCX016	283.00
Housing 4P		ISCPMPCX014	457.00
Carrier Assembly 2P		ISSPEX0447	81.00
Carrier Assembly 4P		ISSPEX0446	118.00
2P Contactor Coil	140 V - 270 V	ISSPEP0008	609.00
4P Contactor Coil	200 V - 400 V	ISSPEP0007	696.00
	415 V (260 V - 440 V)	ISSPEP0009	
	240 V (140 V - 270 V)	ISSPEP0011	
Single Fixed Contact 2P / 4P	20 A	ISSPEX0428	95.00
	25 A	ISSPEX0429	129.00
	32 A	ISSPEX0430	138.00
	40 A	ISSPEX0439	166.00
Single Moving Contact 2P / 4P	20 A	ISSPEX0431	144.00
	25 A	ISSPEX0432	204.00
	32 A	ISSPEX0433	232.00
	40 A	ISSPEX0440	283.00
Contact Kit 2P Contactor	20 A	ISSPEX0441	653.00
	25 A	ISSPEX0442	918.00
	40 A	ISSPEX0444	1209.00
Contact Kit 4P Contactor	20 A	ISSPEX0434	1186.00
	25 A	ISSPEX0435	1846.00
	32 A	ISSPEX0436	1984.00
	40 A	ISSPEX0445	1977.00



Spares - Motor Starters & Controllers

DOL Starter - Spares

HSN Code: 8538

Type	Item Code	Per Unit LP (₹)
NO Switch URJA	ISSPEX0437	138.00
ON / OFF Push Button Assembly URJA	ISSPEX0438	



NO Switch



ON / OFF PB

Single Phase Sub. Starter - Spares

HSN Code: 8538

Type	Item Code	Per Unit LP (₹)
PB Red for SPSS with 1NC Element	ISCELXLX0001	204.00
5+16 Element (1.5-2 HP) 1.12 kW - 1.50 kW	ISCELXLX0002	385.00
	ISCELXLX0003	442.00
5+25 Element (3-5 HP) 2.24 kW - 3.73 kW	ISCELKLX0006	81.00
Neon Light Indicator Red	ISSPEX0427	435.00
Front Add-on Aux.Cont.Blck	ISCELMLX0006	1160.00
Combined AV Meter	ISCELMLX0007	1165.00
	ISCELMLX0008	1282.00
	ISCPMPX032	43.00
Terminal Block	ISCELXPX0003	160.00



PB Red



PB Green



Neon Light



Front Add-on



AV Meter



TB 2Way



TB 5Way

Spares - Motor Starters & Controllers

HSN Code: 8538

Type	Item Code	Per Unit LP (₹)
Start Push Button - Green	ICELL00002	174.00
Stop Push Button - Red	ICELL00003	
Motor ON Indicating Light-Green	ICELKL00015	283.00
Motor Trip Indicating Light-Yellow	ICELKL00013	
SPP	ISCELXL00063	2984.00
Combined Voltmeter & Ammeter	ISCELMLX0007	1165.00
Terminal Block 6 way	ICELPSMX001	435.00
Terminal Block 3 way	ICELPSMX002	262.00
VOLT.SEL SW. C/G	ICELQL00021	406.00
Timer	ICELRPSL005	2571.00
Front Block 1NO 1NC	ISPNAFM711	457.00
Mini Rocker Switch - SPP By Pass	ISCELEL00218	43.00



Start Push Button



Stop Push Button



Motor ON Indicating



Motor Trip Indicating



SPP



AV Meter



TB 6 Way



TB 3 Way



Volt Sel Switch



Timer



Front Block



Mini Rocker Switch



LV Switchgear



ACB Ordning Code Logic

1	2	3	4	5	6	7	8, 9		10		11, 12		13
							Rating	Closing Coil & Charging Motor	CC (voltage)	CM (voltage)	UVT (Voltage)	SHT & UVT	
I	H	A	T	E	Manual Fixed = 1	Bus Coupler = 0	400A = 04	24	220 = A	415	24 = 01	If rating same as ACB rating then = 0	
			TP	50KA	Manual Drawout = 2	IPR 1 = 1	630A = 06	110	220 = B	415	110 = 02	400A = A	
			F	S	Electrical Fixed = 4	IPR 3 = 3	800A = 08	220	220 = C	415	220 = 03	630A = B	
			FP	65KA	Electrical Drawout = 5	IPR 5 = 5	1000A = 10	415	220 = D	415	415 = 04	800A = C	
				H		IPR E = E	1250A = 12	24	110 = E	415	0 = 05	1000A = D	
				75KA			1600A = 16	110	110 = F	220	24 = 06	1250A = E	
							2000A = 20	220	110 = G	220	110 = 07	1600A = F	
							2500A = 25	415	110 = H	220	220 = 08	2000A = G	
								Not req.	Not req. = 0	220	415 = 09	2500A = H	
										220	0 = 10	3200A = I	
										110	24 = 11	4000A = J	
										110	110 = 12	5000A = K	
										110	220 = 13	6300A = L	
										110	415 = 14		
										110	0 = 15		
										24	24 = 16		
										24	110 = 17		
										24	220 = 18		
										24	415 = 19		
										24	0 = 20		
										0	24 = 21		
										0	110 = 22		
										0	220 = 23		
										0	415 = 24		



Titania

Air Circuit Breaker

400 A – 2500 A



Breaking Capacity @ 415 V	E Frame	S Frame	H Frame
	400 A - 2000 A	400 A - 2000 A	2500 A
Ics=100% Icu	50 kA	65kA	75kA
Icw for 1 s	50kA	50kA	65kA





Titania+

Air Circuit Breaker

3200 A – 6300 A

NEW



Breaking Capacity @ 415 V	B Frame	C Frame	D Frame
	3200 A - 4000 A	5000 A	6300 A
Ics=100% Icu	100kA	100kA	150kA
Icw for 1 s	85kA	85kA	100kA



Titania Air Circuit Breaker

(Conforms to IS/IEC:60947-2)



3 Pole ACB with Microprocessor Release IPR 1+

Current Rating	Rated Ultimate Short-circuit Breaking Capacity Ics = 100 % Icu at	MANUAL				ELECTRICAL*	
		Item Code	Per Unit LP (₹)	Item Code	Per Unit LP (₹)	Item Code	
(A)	415 V (kA)	Fixed		Drawout		Fixed	Drawout
630 A	50 kA	IHATE11060**#	128535.00	IHATE21060**#	167100.00	IHATE4106\$\$\$	IHATE5106\$\$\$
800 A	50 kA	IHATE11080**#	128535.00	IHATE21080**#	167100.00	IHATE4108\$\$\$	IHATE5108\$\$\$
1000 A	50 kA	IHATE11100**#	131035.00	IHATE21100**#	170345.00	IHATE4110\$\$\$	IHATE5110\$\$\$
1250 A	50 kA	IHATE11120**#	143100.00	IHATE21120**#	180200.00	IHATE4112\$\$\$	IHATE5112\$\$\$
1600 A	50 kA	IHATE11160**#	156065.00	IHATE21160**#	196100.00	IHATE4116\$\$\$	IHATE5116\$\$\$
2000 A	50 kA	IHATE11200**#	180200.00	IHATE21200**#	236640.00	IHATE4120\$\$\$	IHATE5120\$\$\$

3 Pole ACB with Microprocessor Release IPR 1+

Current Rating	Rated Ultimate Short-circuit Breaking Capacity Ics = 100 % Icu at	MANUAL				ELECTRICAL*	
		Item Code	Per Unit LP (₹)	Item Code	Per Unit LP (₹)	Item Code	
(A)	415 V (kA)	Fixed		Drawout		Fixed	Drawout
630 A	65 kA	IHATS11060**#	139920.00	IHATS21060**#	215425.00	IHATS4106\$\$\$	IHATS5106\$\$\$
800 A	65 kA	IHATS11080**#	139920.00	IHATS21080**#	215425.00	IHATS4108\$\$\$	IHATS5108\$\$\$
1000 A	65 kA	IHATS11100**#	146420.00	IHATS21100**#	232805.00	IHATS4110\$\$\$	IHATS5110\$\$\$
1250 A	65 kA	IHATS11120**#	177200.00	IHATS21120**#	256940.00	IHATS4112\$\$\$	IHATS5112\$\$\$
1600 A	65 kA	IHATS11160**#	187535.00	IHATS21160**#	279425.00	IHATS4116\$\$\$	IHATS5116\$\$\$
2000 A	65 kA	IHATS11200**#	201400.00	IHATS21200**#	296800.00	IHATS4120\$\$\$	IHATS5120\$\$\$
2500 A	75 kA	IHATH11250**#	233640.00	IHATH21250**#	348125.00	IHATH4125\$\$\$	IHATH5125\$\$\$

* Please refer table A to Product price list

To replace \$ Please refer table 1 at page-39

To replace ** Please refer table 2 at page-39

To replace # Please refer table 3 at page-39

Door Flange (Escutcheon Frame) is supplied alongwith ACB

Titania Air Circuit Breaker

(Conforms to IS/IEC:60947-2)

4 Pole ACB with Microprocessor Release IPR 1+

Current Rating	Rated Ultimate Short-circuit Breaking Capacity Ics = 100 % Icu at	MANUAL				ELECTRICAL*	
		Item Code	Per Unit LP (₹)	Item Code	Per Unit LP (₹)	Item Code	
(A)	415 V (kA)	Fixed		Drawout		Fixed	Drawout
630 A	50 kA	IHAFF11060**#	162735.00	IHAFF21060**#	206700.00	IHAFF4106\$***	IHAFF5106\$***
800 A	50 kA	IHAFF11080**#	162735.00	IHAFF21080**#	206700.00	IHAFF4108\$***	IHAFF5108\$***
1000 A	50 kA	IHAFF11100**#	169960.00	IHAFF21100**#	220945.00	IHAFF4110\$***	IHAFF5110\$***
1250 A	50 kA	IHAFF11120**#	175780.00	IHAFF21120**#	228510.00	IHAFF4112\$***	IHAFF5112\$***
1600 A	50 kA	IHAFF11160**#	194885.00	IHAFF21160**#	251016.00	IHAFF4116\$***	IHAFF5116\$***
2000 A	50 kA	IHAFF11200**#	230650.00	IHAFF21200**#	298920.00	IHAFF4120\$***	IHAFF5120\$***

4 Pole ACB with Microprocessor Release IPR 1+

Current Rating	Rated Ultimate Short-circuit Breaking Capacity Ics = 100 % Icu at	MANUAL				ELECTRICAL*	
		Item Code	Per Unit LP (₹)	Item Code	Per Unit LP (₹)	Item Code	
(A)	415 V (kA)	Fixed		Drawout		Fixed	Drawout
630 A	65 kA	IHAFFS11060**#	176315.00	IHAFFS21060**#	304345.00	IHAFFS4106\$***	IHAFFS5106\$***
800 A	65 kA	IHAFFS11080**#	176315.00	IHAFFS21080**#	304345.00	IHAFFS4108\$***	IHAFFS5108\$***
1000 A	65 kA	IHAFFS11100**#	204080.00	IHAFFS21100**#	312245.00	IHAFFS4110\$***	IHAFFS5110\$***
1250 A	65 kA	IHAFFS11120**#	228585.00	IHAFFS21120**#	349735.00	IHAFFS4112\$***	IHAFFS5112\$***
1600 A	65 kA	IHAFFS11160**#	267600.00	IHAFFS21160**#	409430.00	IHAFFS4116\$***	IHAFFS5116\$***
2000 A	65 kA	IHAFFS11200**#	286200.00	IHAFFS21200**#	417875.00	IHAFFS4120\$***	IHAFFS5120\$***
2500 A	75 kA	IHAFFH11250**#	307400.00	IHAFFH21250**#	427345.00	IHAFFH4125\$***	IHAFFH5125\$***

Titania +

Rating*	Pole	MANUAL		ELECTRICAL	
		Fixed	Drawout	Fixed	Drawout
3200 A	3 Pole / 4 Pole	Price on Request			
4000 A					
5000 A					
6300 A					



* Please refer table A to Product price list
 To replace \$ Please refer table 1 at page-39
 To replace ** Please refer table 2 at page-39
 To replace # Please refer table 3 at page-39

Table - A

List prices Charges for product different version wrt IPR1+ ACB List Price		Per Unit LP (₹)
Bus Coupler w/o Protection	Reduce	18825.00
Micro processor release IPRE+ (LI)	Reduce	8160.00
Micro processor release IPR3+ (LSIG+ LCD Display+Thermal Memory+ Zone selectivity+ Current & Voltage Mesurment+ Advance protection +Over Tempeture Protection)	Add	27705.00
Micro processor release IPR5+(LCD Display+Thermal Memory+ Zone selectivity+ Advance protection+ Advance Mesurment Over Tempeture Protection+ Maximum Demand + Comunication)	Add	38565.00
To Convert Electrical version from Manual version (includes Motor, Shunt trip & Closing Coil)	Add	43735.00

1. Communication Software

HSN Code: 8538

S.No.	SAP Code	Description	Per Unit LP (₹)
1	SACX0346	Communication software for IRP-5+	POR

2. Spring Charging Motor

HSN Code: 8538

S.No.	SAP Code	Description	Per Unit LP (₹)
1	ISACX0358	Charging Motor 110 V	36995.00
2	ISACX0147	Charging Motor 230 V	36995.00

3. Main CTs

HSN Code: 8504

S.No.	SAP Code	Description	Per Unit LP (₹)
1	ICELFACL018	CT 400 A	3195.00
2	ICELFACL001	CT 630 A	3195.00
3	ICELFACL002	CT 800 A	3195.00
4	ICELFACL003	CT 1000A	3365.00
5	ICELFACL004	CT 1250 A	3365.00
6	ICELFACL005	CT 1600 A	3365.00
7	ICELFACL006	CT 2000 A	4520.00
8	ICELFACL007	CT 2500A	4520.00

4. Neutral CTs

HSN Code: 8504

S.No.	SAP Code	Description	Per Unit LP (₹)
1	ICELFACL019	NCT 400 A	3195.00
2	ICELFACL012	NCT 630 A	3195.00
3	ICELFACL013	NCT 800 A	3195.00
4	ICELFACL014	NCT 1000A	3365.00
5	ICELFACL015	NCT 1250 A	3365.00
6	ICELFACL016	NCT 1600 A	3365.00
7	ICELFACL017	NCT 2000 A	4520.00
8	ICELFACL021	NCT 2500A	4520.00



Undervoltage release

5. Under Voltage Trip Device (UVT)

HSN Code: 8538

S.No.	SAP Code	Description	Per Unit LP (₹)
1	ISACX0196	220 VAC	4740.00
2	ISACX0197	415 VAC	4740.00



Shunt Trip Coil / Closing Coil

6. Shunt Trip / Closing Coil

HSN Code: 8538

S.No.	SAP Code	Description	Per Unit LP (₹)
1	ISACX0170	24 VDC	3370.00
2	ISACX0168	110 VAC/DC	3370.00
3	ISACX0167	220 VAC/DC	3370.00
4	ISACX0212	415 VAC	3370.00

Titania Air Circuit Breaker

(Conforms to IS/IEC:60947-2)



ON/OFF push button cover



Door Interlock



Drawout position lock



Adaptor terminals for Cradle

7. Key Lock / Key Interlock

HSN Code: 8301

S.No.	SAP Code	Description	Per Unit LP (₹)
1	ISACX0301	On/Off Button cover	430.00
2	ISACX0353	Key lock (1 lock+1 key)	1735.00
3	ISACX0181	Key interlock (2 locks+1 keys)	2425.00
4	ISACX0210	Key interlock (3 locks+2 keys)	5110.00
5	ISACX0341	Drawout position Lock	2105.00

8. Adaptor Type Terminals (additional price)

(6 nos. reqd. for 3 pole & 8 nos. for 4 pole ACB) HSN Code: 8538

S.No.	SAP Code	Description	Per Unit LP (₹)
1	ISSACX0174	630/800 A	4565.00
2	ISSACX0164	1000/1250 A	5020.00
3	ISSACP0434	1600 A	7100.00

9. Other Accessories

HSN Code: 8538

S.No.	SAP Code	Description	Per Unit LP (₹)
1	ISACX0208	Door Interlock	3085.00
2	ISACX0028	Close open cycle counter	3040.00



Position Indication Switch



Auxiliary Contacts

*ACBs are supplied with following accessories as standard fitment:

Manual Fixed	Manual Drawout	Electrical Fixed	Electrical Drawout
Aux. Contact Unit 5CO	Aux. Contact Unit 5CO Safety Shutter Aux. Isolating contact unit Horizontal Terminals	Horizontal Terminals Shunt Trip Device Charging Motor Closing Coil	Aux. Contact Unit 5CO Safety Shutter Aux. Isolating contact unit Horizontal Terminals Shunt Trip Device Charging Motor Closing Coil

*Additional accessories except standard fitment are available on extra price.

*Neutral CT is supplied as a standard fitment in 4 Pole ACBs.

*Neutral CT prices are to be added for 3 Pole ACBs for ground fault protection.

*All orders should be accompanied with ACB order form included in catalogue.

*1 This CT is required for GFT in 3 pole ACBs for 4 Pole ACBs main CTs is used as neutral CT.

10. Other Accessories

HSN Code: 8536

S.No.	SAP Code	Description	Per Unit LP (₹)
1	ISACX0207	Spring charge indication switch	2015.00
2	ISACX0349	Trip indication Switch	1270.00
3	ISACX0139	Aux. switch (5 c/o additional)	3095.00
4	ISACX0182	Position indication switch	2215.00
5	ISACX0302	Field test unit	2970.00

Table 1

Closing Coil & Charging Motor		
CC (Voltage)	CM (Voltage)	\$
24 V	220 V	A
110 V	220 V	B
220 V	220 V	C
415 V	220 V	D
24 V	110 V	E
110 V	110 V	F
220 V	110 V	G
415 V	110 V	H

Table 2

UVT & SHT		
UVT (Voltage)	SHT (Voltage)	**
415 V	24 V	01 (Zero one)
415 V	110 V	02
415 V	220 V	03
415 V	415 V	04
415 V	0	05
220 V	24 V	06
220 V	110 V	07
220 V	220 V	08
220 V	415 V	09
220 V	0	10
110 V	24 V	11
110 V	110 V	12
110 V	220 V	13
110 V	415 V	14
110 V	0	15
24 V	24 V	16
24 V	110 V	17
24 V	220 V	18
24 V	415 V	19
24 V	0	20
0	24 V	21
0	110 V	22
0	220 V	23
0	415 V	24
0	0	00 (Zero Zero)

Table 3

Current Transformer	#
CT Rating is same as of ACB	0 (Zero)
400 A	A
630 A	B
800 A	C
1000A	D
1250 A	E
1600 A	F
2000 A	G

Intelligent Protection Releases

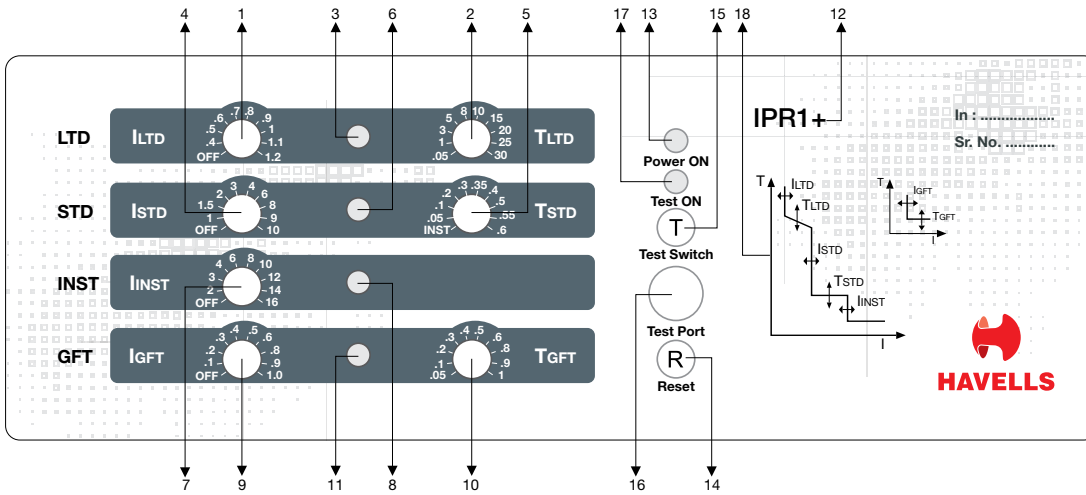

Ref.	Description	Ref.	Description
1	Rotary switch for setting LTD current	10	Rotary switch for setting GFT time
2	Rotary switch for setting LTD Time	11	LED indication for GFT fault
3	LED indication for LTD fault	12	Product identification code
4	Rotary switch for setting STD current	13	LED for "Power ON"
5	Rotary switch for setting STD time	14	Reset push button
6	LED indication for STD fault	15	Test push button
7	Rotary switch for setting INST current	16	Socket for test supply
8	LED indication for INST fault	17	LED for "Test ON"
9	Rotary switch for setting GFT current	18	Time current characteristics curve

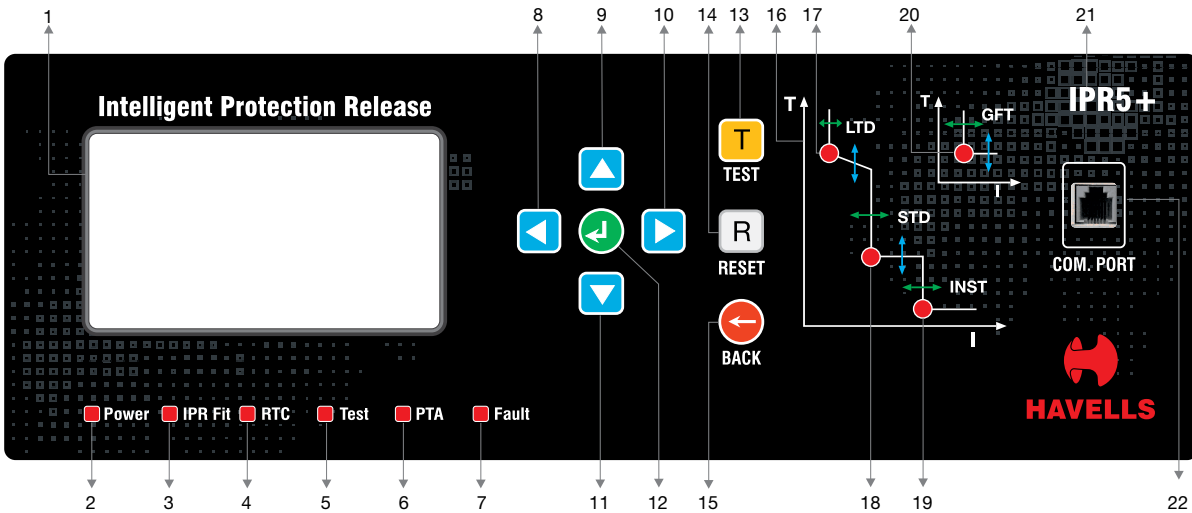

Ref.	Description	Ref.	Description
1	LCD Screen	12	Enter / Save Push Button
2	LED for "Power ON"	13	Test Push Button
3	LED for "IPR Fit"	14	Reset Push Button
4	#LED for "RTC (Ready to Close)"	15	Back Push Button
5	LED for "Test ON"	16	Time Current Characteristic Curve
6	LED for "PTA (Pre-Trip Alarm)"	17	LED Indication for LTD Fault
7	LED for "Faults"	18	LED Indication for STD Fault
8	Scroll "Left" Push Button	19	LED Indication for INST Fault
9	Scroll "Up" Push Button	20	LED Indication for GFT Fault
10	Scroll "Right" Push Button	21	Product Identification Code
11	Scroll "Down" Push Button	22	MODBUS RS-485 Communication Port

Titania Air Circuit Breaker

(Conforms to IS/IEC:60947-2)

New Range of Intelligent Protection Release (IPR)+ (400 A - 2500 A)



S. No.	Features	IPR E+	IPR 1+	IPR 3+	IPR 5+
	Release settings:	●	●	●	●
1	LTD	Current Setting	●	●	●
		Time Setting	●	●	●
2	STD	Current Setting	●	●	●
		Time Setting	●	●	●
3	INST	●	●	●	●
4	GFT	Current Setting	●	●	●
		Time Setting	●	●	●
5	PTA	Current Setting		●	●
		Time Setting		●	●
6	Function Blocking	●	●	●	●
7	Field Test Function	●	●	●	●
8	IPR Fit Indicator			●	●
9	Load Shedding Function			●	●
10	Reset Function	●	●	●	●
11	Thermal Memory			●	●
12	LED Indications	●	●	●	●
13	Fault History on Display			●	●
14	Making Current Release	●	●	●	●
15	Zone Selectivity			●	●
16	Circuit Breaker Fail Protection			●	●
17	Operation Counter			●	●
18	Contact Erosion Indicator			●	●
19	Ready to Close (RTC)*			●	●
20	I ² t ON/OFF			●	●
21	LCD Display			●	●
22	Bar Graphs Indication			●	●
23	External Relay Card*			●	●
	Advanced Protection			●	●
24	Under Voltage Release			●	●
25	Over Voltage Release			●	●
26	Under Frequency protection			●	●
27	Over Frequency protection			●	●
28	Voltage unbalance protection			●	●
29	Phase sequence protection			●	●
30	Over Temperature Protection			●	●
	Measurement Module			●	●
31	Current (Both in 3 phase & neutral)			●	●
32	Voltage (both Line & Phase)			●	●
33	Frequency			●	●
34	Temperature (°C)			●	●
35	Maximum Demand				●
36	Apparent Power (kVA)				●
37	Real Power (kW)				●
38	Reactive Power (kVAr)				●
39	Power factor				●
40	Communication Enabled (MODBUS)				●

*Provided on request.

Communication software provided on request.

Note: IPR+ releases do not require any external power supply for their basic protection functioning. For other functions and display to run, they require an external power supply of 12 Vdc - 24 Vdc.

**Protection Release for Titania+
(3200 A - 6300 A)**

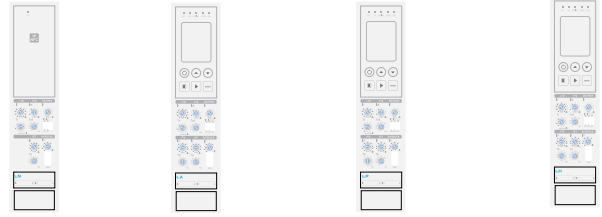

Model Name	N Type	A Type	P Type	H Type
	LN	LA	LP	LH
Frequency				
50 Hz	50 Hz	50 Hz	50 Hz	50 Hz
60 Hz	60 Hz	60 Hz	60 Hz	60 Hz
Control Power				
External Power	-	●	●	●
Self-Power	●	●	●	●
Protection Function				
LTD (Long Time)	●	●	●	●
STD (Short Time)	●	●	●	●
INST (Instantaneous)	●	●	●	●
Pre-Trip Alarm	-	●	●	●
Ground Fault Trip	●	●	●	●
Thermal Function	●	●	●	●
Field Test	-	●	●	●
Fail Safe	●	●	●	●
Indication				
True RMS Detection Method	●	●	●	●
LED Indication per Trip Type	-	●	●	●
Fault LED	L ¹⁾	PTA, L, S/I, G	PTA, L, S/I, G	PTA, L, S/I, G
Real-Time LCD Indication of Load Rate per Phase	-	●	●	●
Measurement LCD	-	●	●	●
3 Phase current	-	●	●	●
Voltage	-	-	●	●
Power	-	-	●	●
Power factor & power quantity	-	-	●	●
Demand	-	-	●	●
Zone selective interlocking	-	●	●	●
Voltage / current harmonics (1st ~ 63 th)	-	-	-	●
3 Phase wave form	-	-	-	●
TDH, TDD	-	-	-	●
Output Contact				
Integrated Instantaneous Contact (1a)	●	-	-	-
Individual Continuous Contact (4a)	-	●	●	●
Operation				
MCR	-	○	○	○
Communication	NFC	Modbus-RTU	Modbus-RTU	Modbus-RTU
Event/Fault Recording	●	●	●	●

● Standard ○: Option

1) Indicates reserve before operation during long time delay.

Titania Air Circuit Breaker

(Conforms to IS/IEC:60947-2)

Order Form

Please check in front of appropriate box. Fill separate sheet for each type of ACB

CUSTOMER/ DEALER NAME	ORDER NO./DATE		END USER NAME				
Rating of ACB	630 A <input type="checkbox"/>	1000 A <input type="checkbox"/>	1600 A <input type="checkbox"/>	2500 A <input type="checkbox"/>	4000 A <input type="checkbox"/>	6300 A <input type="checkbox"/>	Qty.
	800 A <input type="checkbox"/>	1250 A <input type="checkbox"/>	2000 A <input type="checkbox"/>	3200 A <input type="checkbox"/>	5000 A <input type="checkbox"/>		
Breaking Capacity Icu	Upto 2500 A	50 kA <input type="checkbox"/>	65 kA <input type="checkbox"/>	75 kA <input type="checkbox"/>			
	3200 A to 6300 A		100 kA <input type="checkbox"/>	150 kA <input type="checkbox"/>			
No. of Poles		3 <input type="checkbox"/>	4 <input type="checkbox"/>	4 <input type="checkbox"/>			
			(100% Neutral)	(50% Neutral for V-Series only)			
Mounting	Fixed <input type="checkbox"/>	Drawout <input type="checkbox"/>	Standard (for E&S series) <input type="checkbox"/>		Vertical terminals (for H&V series) <input type="checkbox"/>		
	Note: For E & S series - Adapter terminals are on demand						
Spring Charging Operation	Manual <input type="checkbox"/>	Electrical <input type="checkbox"/>	Closing Coil _____ VAC / DC		Tripping Coil _____ VAC / DC		Motor _____ V
Release	Upto 2500 A	<input type="checkbox"/>	<input type="checkbox"/>	<input type="checkbox"/>	<input type="checkbox"/>	<input type="checkbox"/>	
		Without Release	IPR E +	IPR 1 +	IPR 3 +	IPR 5 +	
	3200 A to 6300 A	<input type="checkbox"/>	<input type="checkbox"/>	<input type="checkbox"/>	<input type="checkbox"/>	<input type="checkbox"/>	
		Without Release	LN	LA	LP	LH	
	Setting: O/L _____ A, S/C _____ A, Inst. _____ A, GFT _____ A, CT Rating _____ A, Neutral CT <input type="checkbox"/>						
	Note: Unless otherwise specified O/L will be set at maximum value and all other settings would be set at mid values.						
Other Accessories	Close open cycle counter	<input type="checkbox"/>	Five c/o additional Aux. contacts	<input type="checkbox"/>			
	Field test unit	<input type="checkbox"/>	Shunt Trip	<input type="checkbox"/>			
	Position Indication Switch	<input type="checkbox"/>	UVT	<input type="checkbox"/>			
	Spring Charge Indication Switch	<input type="checkbox"/>	Trip Indication Switch	<input type="checkbox"/>			
	Door Interlock	<input type="checkbox"/>	Key Interlock	1L+1K	<input type="checkbox"/>		
				2L+1K	<input type="checkbox"/>		
			3L+2K	<input type="checkbox"/>			

Note :

- Please specify the voltages for closing coil, shunt trip coil and UVT, available voltages are 24 VDC, 110 VAC / DC, 220 VAC / DC and 415 VAC and for motor available voltages are 220 VAC / DC and 110 VAC / DC.
- For details of Protection Releases, please refer the chart of technical features.

Compact, Reliable & Robust

HIM - Moulded Case Circuit Breakers



Wide range of Circuit Breakers catering all kind of electrical applications

- HIM Series MCCBs upto 800 A are the natural selection for all kind of electrical distribution / applications.
- Double protective layer ensures high level of safety.
- High Electrical / Mechanical endurance for upgraded service life / dependability.
- All type of accessories for different frame provide greater control over distribution.
- Suitable for isolation.

Advanced Breaking Performance and Various Selectivity

- Wide Product Range: 100 A - 800 A in 5 different frames.
- Thermal magnetic release with thermal adjustability in entire range.
- High breaking capacity with $I_{cs} = 100\% I_{cu}$ from 16 kA to 85 kA.
- 2P, 3P and 4P versions available.
- Standardized Height of Products by Frame: 100 A - 250 A (68 mm), 400 A - 800 A (110 mm).

Rated Short-Circuit Current by Ampere Frame, ($I_{cs} = 100\% I_{cu}$)

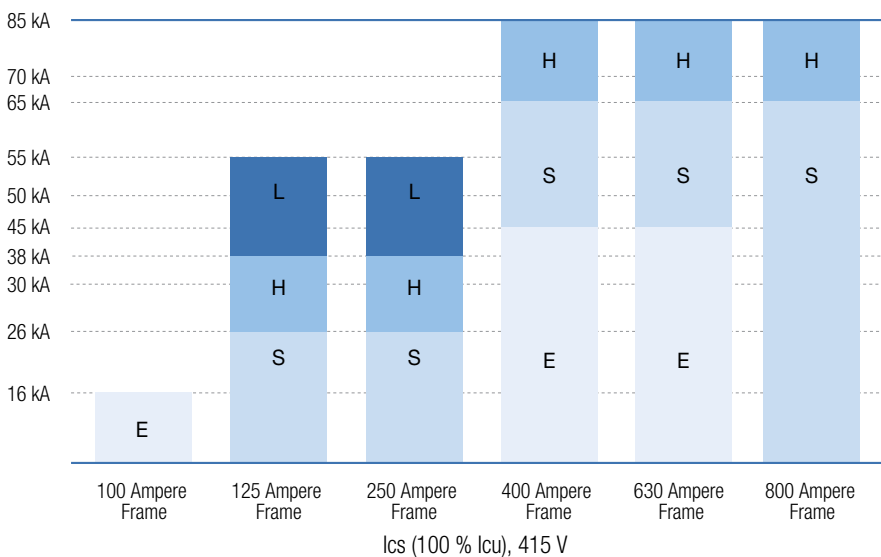

Moulded Case Circuit Breakers

(Conforms to IS/IEC:60947-2)



HIM MCCB

Conforms to IS/IEC60947-2

Ics=Icu=100%

16A to 800A

Up to 85kA breaking capacities

Adjustable Thermal & Fixed Magnetic



Rated Ultimate Short-circuit Breaking Capacity Ics=100% Icu at 415 Vac (kA rms)	Rated Ultimate Short-circuit Breaking Capacity Icu at 250 V (2P)-DC (kA)	Current Rating (A)	Frame	Double Pole Cat. No.	Per Unit LP (₹)	Three Pole Cat. No.	Per Unit LP (₹)	Four Pole # Cat. No.	Per Unit LP (₹)			
16	5	16	HIM 100	IHDA3BBD0016	3360.00	IHDA3BBT0016	4625.00	IHDA3BBF0016	5940.00			
		20		IHDA3BBD0020		IHDA3BBT0020		IHDA3BBF0020				
		25		IHDA3BBD0025		IHDA3BBT0025		IHDA3BBF0025				
		32		IHDA3BBD0032		IHDA3BBT0032		IHDA3BBF0032				
		40		IHDA3BBD0040		IHDA3BBT0040		IHDA3BBF0040				
		50		IHDA3BBD0050		IHDA3BBT0050		IHDA3BBF0050				
		63		IHDA3BBD0063		IHDA3BBT0063		IHDA3BBF0063				
		80		IHDA3BBD0080		IHDA3BBT0080		IHDA3BBF0080				
		100		IHDA3BBD0100	3690.00	IHDA3BBT0100	5060.00	IHDA3BBF0100	6530.00			
26	15	16	HIM 125	IHDA6OBD0016	5520.00	IHDA6OBT0016	7540.00	IHDA6OBF0016	10400.00			
		20		IHDA6OBD0020		IHDA6OBT0020		IHDA6OBF0020				
		25		IHDA6OBD0025		IHDA6OBT0025		IHDA6OBF0025				
		32		IHDA6OBD0032		IHDA6OBT0032		IHDA6OBF0032				
		40		IHDA6OBD0040		IHDA6OBT0040		IHDA6OBF0040				
		50		IHDA6OBD0050		IHDA6OBT0050		IHDA6OBF0050				
		63		IHDA6OBD0063		IHDA6OBT0063		IHDA6OBF0063				
		80		IHDA6OBD0080		IHDA6OBT0080		IHDA6OBF0080				
				100		IHDA6OBD0100	6650.00	IHDA6OBT0100	9060.00	IHDA6OBF0100	12555.00	
				125		IHDA6OBD0125		IHDA6OBT0125		IHDA6OBF0125		
				150	HIM 250					IHD2HOBT0150		IHD2HOBF0150
				160				IHD2HOBT0160		IHD2HOBF0160		
		200		IHD2HOBT0200		IHD2HOBF0200						
		225				IHD2HOBT0225	IHD2HOBF0225					
		250				IHD2HOBT0250	IHD2HOBF0250	28915.00				
38	20	16	HIM 125	IHDA6TBD0016	7750.00	IHDA6TBT0016	10670.00	IHDA6TBF0016	13200.00			
		20		IHDA6TBD0020		IHDA6TBT0020		IHDA6TBF0020				
		25		IHDA6TBD0025		IHDA6TBT0025		IHDA6TBF0025				
		32		IHDA6TBD0032		IHDA6TBT0032		IHDA6TBF0032				
		40		IHDA6TBD0040		IHDA6TBT0040		IHDA6TBF0040				
		50		IHDA6TBD0050		IHDA6TBT0050		IHDA6TBF0050				
		63		IHDA6TBD0063		IHDA6TBT0063		IHDA6TBF0063				
		80		IHDA6TBD0080		IHDA6TBT0080		IHDA6TBF0080				
				100		IHDA6TBD0100	8800.00	IHDA6TBT0100	12180.00	IHDA6TBF0100	14820.00	
				125		IHDA6TBD0125		IHDA6TBT0125		IHDA6TBF0125		
				150	HIM 250					IHD2HTBT0150		IHD2HTBF0150
				160				IHD2HTBT0160		IHD2HTBF0160		
		200		IHD2HTBT0200		IHD2HTBF0200						
		225				IHD2HTBT0225	IHD2HTBF0225					
		250				IHD2HTBT0250	IHD2HTBF0250	29275.00				
45	20	300	HIM 400			IHDA9UBT0300	29400.00	IHDA9UBF0300	35510.00			
		350			IHDA9UBT0350	IHDA9UBF0350						
		400		IHDA9UBT0400	42450.00	IHDA9UBF0400						
		500	HIM 630				IHD3HUBT0500	IHD3HUBF0500				
		630				IHD3HUBT0630	IHD3HUBF0630					

Note : Adjustable thermal (80% -100%) - In TP & FP upto HIM 250. #FP with Switched Neutral.
Adjustable thermal (63% -100%) - In TP & FP From HIM 400 to HIM 800.
2 nos for TP & 3 nos for FP phase separator is available in standard packaging alongwith MCCB.
MCCBs are without extended terminals, however extended terminals are available on request at extra price for these ratings



Rated Ultimate Short-circuit Breaking Capacity Ics=100% Icu at 415 Vac (kA rms)	Rated Ultimate Short-circuit Breaking Capacity Icu at 250 V (2P)-DC (kA)	Current Rating (A)	Frame	Double Pole Cat. No.	Per Unit LP (₹)	Three Pole Cat. No.	Per Unit LP (₹)	Four Pole # Cat. No.	Per Unit LP (₹)					
55	30	16	HIM 125	IHDA6VBD0016	9840.00	IHDA6VBT0016	13645.00	IHDA6VBF0016	16630.00					
		20		IHDA6VBD0020		IHDA6VBT0020		IHDA6VBF0020						
		25		IHDA6VBD0025		IHDA6VBT0025		IHDA6VBF0025						
		32		IHDA6VBD0032		IHDA6VBT0032		IHDA6VBF0032						
		40		IHDA6VBD0040		IHDA6VBT0040		IHDA6VBF0040						
		50		IHDA6VBD0050		IHDA6VBT0050		IHDA6VBF0050						
		63		IHDA6VBD0063		IHDA6VBT0063		IHDA6VBF0063						
		80		IHDA6VBD0080		IHDA6VBT0080		IHDA6VBF0080						
		100		IHDA6VBD0100		IHDA6VBT0100		IHDA6VBF0100						
		125		IHDA6VBD0125		IHDA6VBT0125		IHDA6VBF0125						
		150	HIM 250		IHD2HVBT0150	22870.00	IHD2HVBF0150	27265.00						
		160			IHD2HVBT0160		IHD2HVBF0160							
		200			IHD2HVBT0200		IHD2HVBF0200							
		225			IHD2HVBT0225		IHD2HVBF0225							
250	IHD2HVBT0250	IHD2HVBF0250												
65	25	300	HIM 400			IHDA9LBT0300	30700.00	IHDA9LBF0300	36325.00					
		350				IHDA9LBT0350		IHDA9LBF0350						
		400				IHDA9LBT0400		IHDA9LBF0400						
		500	HIM 630				IHD3HLBT0500	44045.00	IHD3HLBF0500	54140.00				
		630					IHD3HLBT0630		IHD3HLBF0630					
		700	HIM 800				IHD4HLBT0700	49760.00	IHD4HLBF0700	64195.00				
		800					IHD4HLBT0800		IHD4HLBF0800					
		300					HIM 400						IHDA9MBT0300	38010.00
350	IHDA9MBT0350	IHDA9MBF0350												
400	IHDA9MBT0400	IHDA9MBF0400												
500	HIM 630				IHD3HMBT0500	51735.00		IHD3HMBF0500		63605.00				
630					IHD3HMBT0630			IHD3HMBF0630						
700	HIM 800				IHD4HMBT0700	59495.00		IHD4HMBF0700		76535.00				
800					IHD4HMBT0800			IHD4HMBF0800						

Accessories for HIM Series Moulded Case Circuit Breakers

Description	HIM 100 / 125 / 250 / Frame	HIM 400 / 630 / 800 Frame	
Shunt Trip			
24 Vdc	ISSLEU0800	1760.00	
48 Vdc	ISSLEU0801		
60 Vdc	ISSLEU0802		
100 Vdc -120 Vdc	ISSLEU1634		
125 Vdc	ISSLEU0803		
100 Vdc -125 Vdc		ISSLEU0907	
100 Vac -120 Vac	ISSLEU0905	1760.00	
200 Vac -250 Vac	ISSLEU0906		ISSLEU0908
380 Vac - 415 Vac	ISLEU0888		ISSLEU0890
			On Request
Under Voltage Release			
24 Vdc	ISSLEU0804	2835.00	
48 Vdc	ISSLEU0805		
100 Vdc - 110 Vdc	ISSLEU0909		
100 Vac - 120 Vac	ISSLEU0910	3470.00	
200 Vac - 230 Vac	ISSLEU0893		ISSLEU0914
380 Vac - 415 Vac	ISSLEU0894		ISSLEU0895
		ISSLEU0896	



SHT



UVT

Note : Adjustable thermal (80% -100%) - In TP & FP upto HIM 250. #FP with Switched Neutral.
 Adjustable thermal (63% -100%) - In TP & FP From HIM 400 to HIM 800.
 2 nos for TP & 3 nos for FP phase separator is available in standard packaging alongwith MCCB.
 MCCBs are without extended terminals, however extended terminals are available on request at extra price for these ratings

Moulded Case Circuit Breakers

(Conforms to IS/IEC:60947-2)

Accessories for HIM Series Moulded Case Circuit Breakers

Description	HIM 100 / 125 / 250 / Frame		HIM 400 / 630 / 800 Frame	
Auxiliary Contact (250 Vac / 250 Vdc) (450 Vac / 250 Vdc)				
1-Changeover	ISSLEU0791	945.00	ISSLEU0793	1040.00
2-Changeover	ISSLEU0792	1675.00		
Alarm Switch (Left side only)	ISSLEU0794	945.00	ISSLEU0796	1040.00
Alarm Switch (Right side only)	ISSLEU0795			
Auxiliary + Alarm Switch				
Left side only	ISSLEU0799	1630.00		
Right side only	ISSLEU0797			
Pad Lock Device	ISSLEU0844	1155.00	ISSLEU0845	1420.00
DIN Rail	ISSLEU0887	830.00		
Auxiliary Handle			ISSLEU0846	1420.00

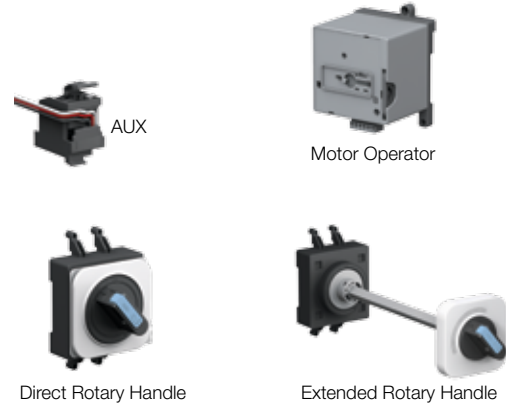

Description	HIM 100 Frame		HIM 125 Frame		HIM 250 Frame		HIM 400 Frame		HIM 630 / 800 Frame	
Rotary Handle										
Direct mounting	ISSLEU0806	1345.00	ISSLEU0809	1345.00	ISSLEU0812	1345.00	ISSLEU0815	1950.00	ISSLEU0916	3040.00
Door Mounting	ISSLEU0820	1780.00	ISSLEU0821	1885.00	ISSLEU0822	2065.00	ISSLEU0823	3205.00	ISSLEU0824	3965.00
Mechanical Interlock										
2 Pole	ISSLEU0825	1300.00	ISSLEU0829	1300.00						
3 Pole	ISSLEU0826	2425.00	ISSLEU0830	2425.00	ISSLEU0833	2940.00	ISSLEU0836	4705.00	ISSLEU0838	5455.00
4 Pole (N-R-S-T)	ISSLEU0828	2890.00	ISSLEU0832	2890.00	ISSLEU0835	3570.00	ISSLEU0837	5515.00	ISSLEU0843	6470.00
Motor Operator										
24 Vdc	ISSLEU0917		ISSLEU0897		ISSLEU0899		ISSLEU0901		ISSLEU0903	
110 Vac / Vdc	ISSLEU0918	29805.00	ISSLEU0920	29805.00	ISSLEU0921	29805.00	ISSLEU0922	42290.00	ISSLEU0923	47120.00
240 Vac / Vdc	ISSLEU0919		ISSLEU0898		ISSLEU0900		ISSLEU0902		ISSLEU0904	

Description	HIM 100 Frame		HIM 125 Frame		HIM 250 Frame		HIM 400 Frame		HIM 630 Frame		HIM 800 Frame	
Spreader Terminals - Extended Type												
3 Pole (Set of 3)	ISSLEX1158	185.00	ISSLEX1160	240.00	ISSLEX1162	650.00	ISSLEX1164	1685.00	ISSLEX1168	1780.00	ISSLEX1166	3660.00
4 Pole (Set of 4)	ISSLEX1159	290.00	ISSLEX1161	345.00	ISSLEX1163	1000.00	ISSLEX1165	2200.00	ISSLEX1169	2385.00	ISSLEX1167	4505.00
Terminal Cover - Long Type												
2 Pole	ISSLEU0858	500.00	ISSLEU0864	500.00								
3 Pole	ISSLEU0859	750.00	ISSLEU0865	750.00	ISSLEU0869	1040.00	ISSLEU0873	2135.00	ISSLEU0877	2135.00		
4 Pole	ISSLEU0860	850.00	ISSLEU0866	850.00	ISSLEU0870	1215.00	ISSLEU0874	2980.00	ISSLEU0878	2980.00		
Phase Barrier												
2 Pole (Set of 1)	ISSLEU0924	60.00	ISSLEU0924	60.00	ISSLEU0882	80.00						
3 Pole (Set of 2)	ISSLEU0880	115.00	ISSLEU0880	115.00	ISSLEU0883	165.00	ISSLEU0885	660.00	ISSLEU0885	660.00	ISSLEU0885	660.00
4 Pole (Set of 3)	ISSLEU0881	175.00	ISSLEU0881	175.00	ISSLEU0884	240.00	ISSLEU0886	990.00	ISSLEU0886	990.00	ISSLEU0886	990.00
Enclosure												
3 Pole	ISSBOU1189	1850.00	ISSBOU1191	1950.00	ISSBOU1193	2540.00	ISSBOU1195	9345.00	ISSBOU1197	9705.00	ISSBOU1199	9705.00
4 Pole	ISSBOU1190		ISSBOU1192		ISSBOU1194		ISSBOU1196		ISSBOU1198		ISSBOU1200	



HAVELLS

The Compact Reliable Performer

Loadline MCCB Range



● Current Rating: 15 A to 1600 A ● Execution: 1P, 2P, 3P & 4P ● Breaking Capacity: 10 kA to 50 kA

□ Compact □ Thermal and Magnetic release □ Precise and reliable protection

Loadline Moulded Case Circuit Breakers

(Conforms to IS/IEC:60947-2)

MCCB Selection Chart

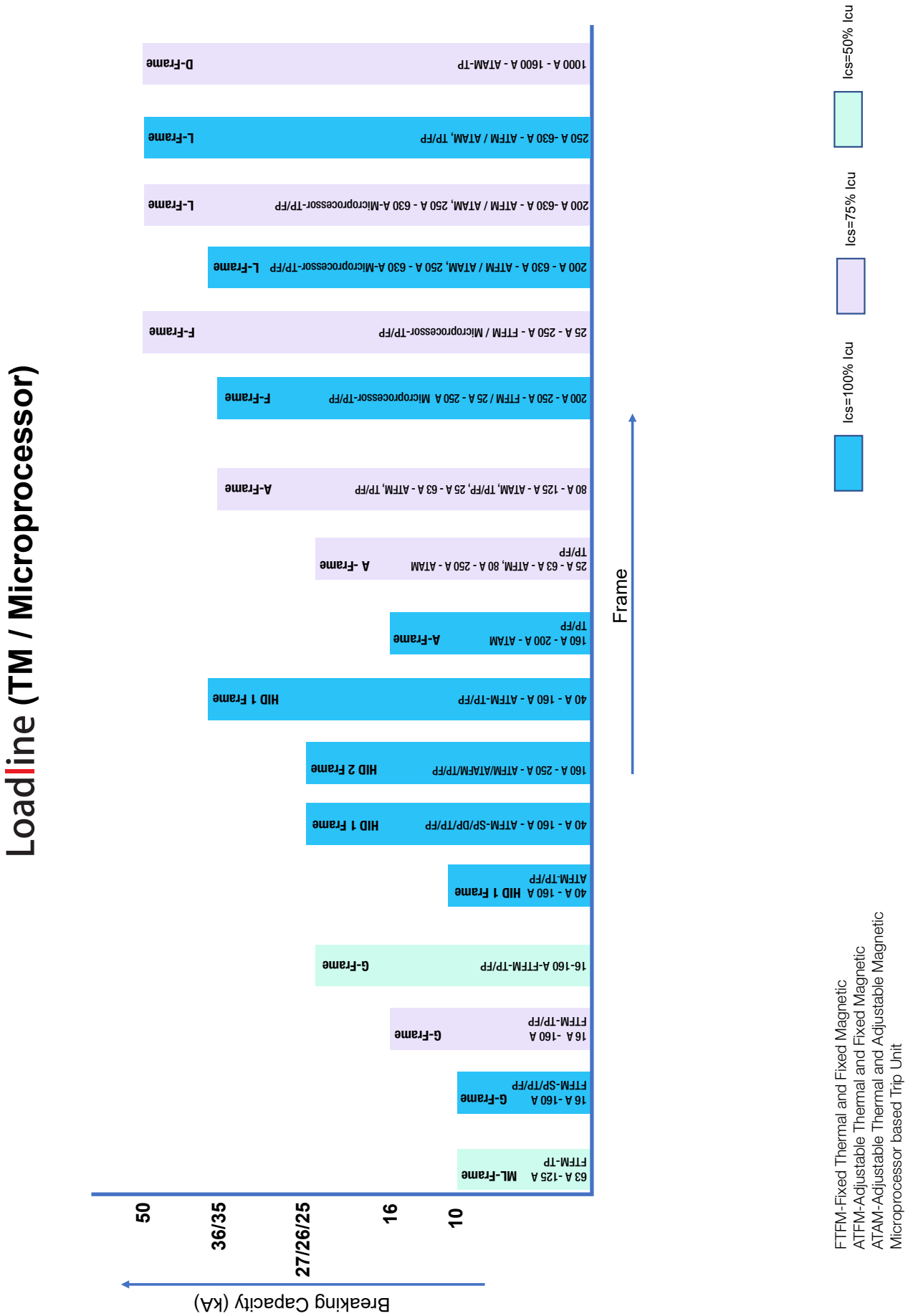

Loadline Moulded Case Circuit Breakers

(Conforms to IS/IEC:60947-2)

Fixed Thermal & Fixed Magnetic

HSN Code: 8536

Rated Ultimate Shortcircuit Breaking Capacity Icu at 415 V (kA rms)	Rated Service short circuit Breaking Capacity Ics = % Icu at 415 V (kA rms)	Current Rating (A)	Frame	Three Pole Cat. No.	Per Unit LP (₹)	Four Pole ## Cat. No.	Per Unit LP (₹)			
10	50%	15 A	SH	IHLSHAAT0015	POR					
		20 A		IHLSHAAT0020						
		32 A		IHLSHAAT0032						
		40 A		IHLSHAAT0040						
		63 A	ML1	IHLM1AAT0063	1935.00					
		80 A		IHLM1AAT0080#	2020.00					
		100 A		IHLM1AAT0100#	2110.00					
		125 A		IHLM1AAT0125#	2765.00					
	100%	25 A	GS	IHLGST0025	2190.00	IHLGSF0025	2860.00			
		32 A		IHLGST0032	2190.00	IHLGSF0032	2860.00			
		40 A		IHLGST0040	2190.00	IHLGSF0040	2860.00			
		50 A		IHLGST0050	2190.00	IHLGSF0050	2860.00			
		63 A		IHLGST0063	2190.00	IHLGSF0063	2890.00			
		80 A		IHLGSAA30080	2190.00	IHLGSAA40080	2930.00			
				IHLGST0080#	2325.00	IHLGSF0080#	3510.00			
		100 A		IHLGS30100	2190.00	IHLGS40100	2930.00			
				IHLGST0100#	2325.00	IHLGSF0100#	3510.00			
		125 A		IHLGST0125#	3405.00	IHLGSF0125#	4030.00			
		150 A		IHLGST0150#	4390.00	IHLGSF0150#	5815.00			
		160 A		IHLGST0160#	4390.00	IHLGSF0160#	5815.00			
16	75%	25 A	GN (Suitable for DC application 5 kA at 250 V DC, 2P in series)	IHLGNT0025	4275.00	IHLGNF0025	5045.00			
		32 A		IHLGNT0032	4275.00	IHLGNF0032	5045.00			
		40 A		IHLGNT0040	4275.00	IHLGNF0040	5045.00			
		50 A		IHLGNT0050	4275.00	IHLGNF0050	5045.00			
		63 A		IHLGNT0063	4220.00	IHLGNF0063	4980.00			
		80 A		IHLGNT0080#	4445.00	IHLGNF0080#	5430.00			
		100 A		IHLGNT0100#	4445.00	IHLGNF0100#	5430.00			
		125 A		IHLGNT0125#	4880.00	IHLGNF0125#	5670.00			
		150 A		IHLGNT0150#	5700.00	IHLGNBAF0150#	6590.00			
		160 A		IHLGNT0160#	5700.00	IHLGNF0160#	6590.00			
		25		50%	25 A	GH	IHLGHT0025	4845.00	IHLGHF0025	6105.00
					32 A		IHLGHT0032	4845.00	IHLGHF0032	6105.00
40 A	IHLGHT0040		4845.00		IHLGHF0040		6105.00			
50 A	IHLGHT0050		4845.00		IHLGHF0050		6105.00			
63 A	IHLGHT0063		4870.00		IHLGHF0063		6130.00			
80 A	IHLGHT0080#		5070.00		IHLGHF0080#		6210.00			
100 A	IHLGHT0100#		5070.00		IHLGHF0100#		6210.00			
125 A	IHLGHT0125#		5900.00		IHLGHF0125#		7765.00			
150 A	IHLGHT0150#		8400.00		IHLGHF0150#		9800.00			
160 A	IHLGHT0160#		8400.00		IHLGHF0160#		9800.00			
35	100%		200 A		FN		IHLFN30200	19670.00	IHLFN40200	24635.00
			250 A				IHLFN30250	22095.00	IHLFN40250	26935.00
50	75%	25 A	FH	IHLFHT0025	11745.00	IHLFHF0025	12460.00			
		32 A		IHLFHT0032	11745.00	IHLFHF0032	12460.00			
		40 A		IHLFHT0040	11745.00	IHLFHF0040	12460.00			
		50 A		IHLFHT0050	11745.00	IHLFHF0050	12460.00			
		63 A		IHLFHT0063	11745.00	IHLFHF0063	12460.00			
		80 A		IHLFHFA30080	12545.00	IHLFHFA40080	13930.00			
		100 A		IHLFH30100	12545.00	IHLFH40100	13930.00			
		125 A		IHLFH30125	14560.00	IHLFH40125	17440.00			
		160 A		IHLFH30160	18060.00	IHLFH40160	21100.00			
		200 A		IHLFH30200	20995.00	IHLFH40200	26485.00			
		250 A		IHLFH30250	23195.00	IHLFH40250	28905.00			

Phase barriers are supplied along with MCCBs
 Spreader terminals are available as an accessories, refer page no. 54
 # Both side terminal are included
 ##FP with Switched Neutral.

Loadline Moulded Case Circuit Breakers

(Conforms to IS/IEC:60947-2)

Adjustable Thermal & Fixed Magnetic

HSN Code: 8536

Rated Ultimate Shortcircuit Breaking Capacity Icu at 415 V (kA rms)	Rated Service short circuit Breaking Capacity Ics = % Icu at 415 V (kA rms)	Current Rating (A)	Frame	Three Pole Cat. No.	Per Unit LP (₹)	Four Pole ## Cat. No.	Per Unit LP (₹)		
10	100%	40 A	HID 1	IHLE1ABT0040	4240.00	IHLE1ABF0040	4945.00		
		50 A		IHLE1ABT0050	4240.00	IHLE1ABF0050	4945.00		
		63 A		IHLE1ABT0063	4240.00	IHLE1ABF0063	4945.00		
		80 A		IHLE1AB30080	4420.00	IHLE1AB40080	5125.00		
		100 A		IHLE1AB30100	4420.00	IHLE1AB40100	5125.00		
		125 A		IHLE1AB30125	5110.00	IHLE1AB40125	6095.00		
		160 A		IHLE1AB30160	6535.00	IHLE1AB40160	7880.00		
25	75%	25 A	AS (Suitable for DC application 10 kA at 250 V DC, 2P in series)	IHLAST0025	6965.00	IHLASF0025	8220.00		
		32 A		IHLAST0032	6965.00	IHLASF0032	8220.00		
		40 A		IHLAST0040	6965.00	IHLASF0040	8220.00		
		50 A		IHLAST0050	6965.00	IHLASF0050	8220.00		
		63 A		IHLAST0063	6965.00	IHLASF0063	8220.00		
27	100%	40 A	HID 1	IHA13DBT0040	6620.00	IHA13DBF0040	7710.00		
		50 A		IHA13DBT0050		IHA13DBF0050			
		63 A		IHA13DBT0063		IHA13DBF0063			
		80 A		IHA13DB30080		IHA13DB40080			
		100 A		IHA13DB30100	IHA13DB40100				
		125 A		IHA13DB30125	7955.00	IHA13DB40125	9485.00		
		160 A		IHA13DB30160	9060.00	IHA13DB40160	10935.00		
35	75%	25 A	AN	IHLANT0025	POR	IHLANF0025	POR		
		32 A		IHLANT0032		IHLANF0032			
		40 A		IHLANT0040		IHLANF0040			
		50 A		IHLANT0050		IHLANF0050			
		63 A		IHLANT0063		IHLANF0063			
36	100%	40 A	HID 1	IHA13EBT0040	9360.00	IHA13EBF0040	11150.00		
		50 A		IHA13EBT0050		IHA13EBF0050			
		63 A		IHA13EBT0063		IHA13EBF0063			
		80 A		IHA13EB30080		IHA13EB40080			
		100 A		IHA13EB30100		IHA13EB40100			
		125 A		IHA13EB30125		10720.00		IHA13EB40125	12645.00
		160 A		IHA13EB30160		11380.00		IHA13EB40160	13310.00
		200 A	LS	IHLLSEB30200	21485.00	IHLLSEB40200	25645.00		
		250 A		IHLLSEB30250	24105.00	IHLLSEB40250	28795.00		
		320 A		IHLLSEB30320	25430.00	IHLLSEB40320	31245.00		
		400 A		IHLLSEB30400	25430.00	IHLLSEB40400	31245.00		
		500 A		IHLLSEB30500	37265.00	IHLLSEB40500	46160.00		
		630 A		IHLLSEB30630	37265.00	IHLLSEB40630	46160.00		
50	75%	200 A	LN	IHLLNFB30200	23815.00	IHLLNFB40200	28195.00		
		250 A		IHLLNFB30250	25760.00	IHLLNFB40250	30475.00		
		320 A		IHLLNFB30320	27305.00	IHLLNFB40320	33040.00		
		400 A		IHLLNFB30400	27305.00	IHLLNFB40400	33040.00		
		500 A		IHLLNFB30500	39805.00	IHLLNFB40500	48865.00		
		630 A		IHLLNFB30630	39805.00	IHLLNFB40630	48865.00		



Adjustable thermal (70%-100%) in TP & FP for HID1 / A frame / D frame
 Adjustable thermal (80%-100%) in TP & FP for L frame
 Phase barriers are supplied along with MCCBs
 Spreader terminals are available as an accessories, refer page no. 54
 # Both side terminal are included
 ##FP with Switched Neutral.

Loadline Moulded Case Circuit Breakers

(Conforms to IS/IEC:60947-2)

Adjustable Thermal & Adjustable Magnetic

HSN Code: 8536

Rated Ultimate Shortcircuit Breaking Capacity Icu at 415 V (kA rms)	Rated Service short circuit Breaking Capacity Ics = % Icu at 415 V (kA rms)	Current Rating (A)	Frame	Three Pole Cat. No.	Per Unit LP (₹)	Four Pole ## Cat. No.	Per Unit LP (₹)
16	100%	160 A	AS	IHLASBC30160	7985.00	IHLASBC40160	10965.00
		200 A		IHLASBC30200	9460.00	IHLASBC40200	11975.00
25	75%	80 A	AS (Suitable for DC application 10 kA at 250 V DC 2P in series)	IHLASDC30080	7090.00	IHLASDC40080	8580.00
		100 A		IHLASDC30100		IHLASDC40100	
		125 A		IHLASDC30125		IHLASDC40125	
		160 A	AN (Suitable for DC application 10 kA at 250 V DC 2P in series)	IHLANDC30160	IHLANDC40160	11760.00	
		200 A		IHLANDC30200	IHLANDC40200	12255.00	
		250 A		IHLANDC30250	IHLANDC40250	13595.00	
35	75%	80 A	AN	IHLANEC30080	9690.00	IHLANEC40080	11555.00
		100 A		IHLANEC30100	9690.00	IHLANEC40100	11555.00
		125 A		IHLANEC30125	11345.00	IHLANEC40125	13090.00
36	100%	200 A	LS	IHLLSEC30200	22440.00	IHLLSEC40200	26325.00
		250 A		IHLLSEC30250	24765.00	IHLLSEC40250	29420.00
		320 A		IHLLSEC30320	27905.00	IHLLSEC40320	34075.00
		400 A		IHLLSEC30400		IHLLSEC40400	
		500 A		IHLLSEC30500	37980.00	IHLLSEC40500	47135.00
		630 A		IHLLSEC30630		IHLLSEC40630	
50	75%	200 A	LN	IHLLNFC30200	26745.00	IHLLNFC40200	31495.00
		250 A		IHLLNFC30250	28865.00	IHLLNFC40250	33960.00
		320 A		IHLLNFC30320	29230.00	IHLLNFC40320	35525.00
		400 A		IHLLNFC30400		IHLLNFC40400	
		500 A		IHLLNFC30500	41040.00	IHLLNFC40500	50220.00
		630 A		IHLLNFC30630		IHLLNFC40630	
	100%	250 A	NEW L	IHLLSFC30250	29500	IHLLSFC40250	35100
		320 A		IHLLSFC30320	30050	IHLLSFC40320	35915
		400 A		IHLLSFC30400		IHLLSFC40400	
		500 A		IHLLSFC30500	42500	IHLLSFC40500	50800
		630 A		IHLLSFC30630		IHLLSFC40630	
	75%	1000 A	DN	IHLDNT1000	143705.00		
		1250 A		IHLDNT1250	164760.00		
		1600 A		IHLDNT1600	177580.00		

Single Pole And Double Pole MCCB

Rated Ultimate Shortcircuit Breaking Capacity Icu at 240 V AC (kA rms)	Rated Service short circuit Breaking Capacity Ics = % Icu at 240 V AC (kA rms)	Current Rating (A)	Frame	Single Pole Cat. No.	Per Unit LP (₹)	Rated Ultimate Shortcircuit Breaking Capacity Icu at 240 V AC (kA rms)	Rated Service short circuit Breaking Capacity Ics = % Icu at 240 V AC (kA rms)	Double Pole Cat. No.	Per Unit LP (₹)	
10	100%	25 A	GS	IHLGSS0025	1010.00	36	100%			
		32 A		IHLGSS0032						
		40 A		IHLGSS0040						
		50 A		IHLGSS0050						
		63 A		IHLGSS0063						
		80 A		IHLGSS0080#	1020.00					
		100 A		IHLGSS0100#	1230.00					
		125 A		IHLGSS0125#						
		150 A		IHLGSS0150#	1325.00					
		160 A		IHLGSS0160#						
27	100%	40 A	HID 1	IHA13DBS0040	3480.00	36	100%	IHA13DBD0040	5090.00	
		50 A		IHA13DBS0050				IHA13DBD0050		
		63 A		IHA13DBS0063				IHA13DBD0063		
		80 A		IHA13DB10080				IHA13DB20080		
		100 A		IHA13DB10100				IHA13DB20100		
		125 A		IHA13DB10125				4180.00		IHA13DB20125
		160 A		IHA13DB10160	4770.00			IHA13DB20160		6975.00

Adjustable thermal (70%-100%) in TP & FP for HID1 / A frame / D frame

Adjustable thermal (80%-100%) in TP & FP for L frame

Please refer catalogue for magnetic adjustability details

Phase barriers are supplied along with MCCBs

Spreader terminals are available as an accessories, refer page no. 54

Both side terminal are included

##FP with Switched Neutral

Loadline Moulded Case Circuit Breakers

(Conforms to IS/IEC:60947-2)

Microprocessor MCCB

Adjustable Overload, Short-circuit, Ground fault (4 Pole) & Fixed Instantaneous
Neutral Protection (4 Pole)

Rated Ultimate Shortcircuit Breaking Capacity Icu at 415 V (kA rms)	Rated Service short circuit Breaking Capacity Ics = % Icu at 415 V (kA rms)	Current Rating (A)	Frame	Three Pole Cat. No.	Per Unit LP (₹)	Four Pole ## Cat. No.	Per Unit LP (₹)	
35	100%	25 A	FEN	IHLFENT0025	15245.00	IHLFENF0025	19735.00	
		32 A		IHLFENT0032		IHLFENF0032		
		40 A		IHLFENT0040		IHLFENF0040		
		50 A		IHLFENT0050		IHLFENF0050		
		63 A		IHLFENT0063		IHLFENF0063		
		80 A		IHLFEN30080		IHLFEN40080		
		100 A		IHLFEN30100		IHLFEN40100		
		125 A		IHLFEN30125		IHLFEN40125		
		160 A		IHLFEN30160		IHLFEN40160		24380.00
		200 A		IHLFEN30200		IHLFEN40200		31340.00
		250 A		IHLFEN30250		IHLFEN40250		
		36		100%		250 A		LES
320 A	IHLLSEE30320		IHLLSEE40320					
400 A	IHLLSEE30400		IHLLSEE40400					
500 A	IHLLSEE30500		IHLLSEE40500		53235.00			
630 A	IHLLSEE30630		IHLLSEE40630					
50	75%	25 A	FEH	IHLFEHT0025	18165.00	IHLFEHF0025	23220.00	
		32 A		IHLFEHT0032		IHLFEHF0032		
		40 A		IHLFEHT0040		IHLFEHF0040		
		50 A		IHLFEHT0050		IHLFEHF0050		
		63 A		IHLFEHT0063		IHLFEHF0063		
		80 A		IHLFEH30080		IHLFEH40080		
		100 A		IHLFEH30100		IHLFEH40100		
		125 A		IHLFEH30125		IHLFEH40125		
		160 A		IHLFEH30160		IHLFEH40160		29405.00
		200 A		IHLFEH30200		IHLFEH40200		35395.00
		250 A		IHLFEH30250		IHLFEH40250		
		250 A		LEN		IHLLNFE30250		38790.00
		320 A	IHLLNFE30320		IHLLNFE40320			
		400 A	IHLLNFE30400		IHLLNFE40400			
		500 A	IHLLNFE30500		IHLLNFE40500	54375.00		
		630 A	IHLLNFE30630		IHLLNFE40630			

Phase barriers are supplied along with MCCBs
 Spreader terminals are available as an accessories, refer page no. 54
 Only one internal accessories can be fitted in microprocessor MCCB
 # Both side terminal are included
 ##FP with Switched Neutral
 For Communication enabled MCCB please contact with nearest branch



Loadline Moulded Case Circuit Breakers

(Conforms to IS/IEC:60947-2)

Spreader Terminal kit (1 side)

Frame Size	RATING	POLE	FG CODES	Per Unit LP (₹)
GS, GN, GH	80 A - 100 A	1P	ISSLGX0153	65.00
		3P	ISSLGX0154	185.00
		4P	ISSLGX0155	290.00
	125 A	1P	ISSLGX0156	80.00
		3P	ISSLGX0157	240.00
		4P	ISSLGX0158	345.00
	160 A	1P	ISSLGX0159	105.00
		3P	ISSLGX0160	320.00
		4P	ISSLGX0161	425.00
AS, AN, AH	80 A~100 A	3P	ISSLAX0121	275.00
		4P	ISSLAX0122	380.00
	125 A~200 A	3P	ISSLAX0124	405.00
		4P	ISSLAX0125	550.00
	250 A	3P	ISSLAX0127	690.00
		4P	ISSLAX0128	1000.00
LS, LN	200 A~400 A	3P	ISSLLX0065	1685.00
		4P	ISSLLX0066	2200.00
	500 A~630 A	3P	ISSLLX0067	1780.00
		4P	ISSLLX0068	2385.00
FN, FH	80 A~100 A	3P	ISSLFX0074	275.00
		4P	ISSLFX0075	380.00
	125 A~160 A	3P	ISSLFX0076	405.00
		4P	ISSLFX0077	550.00
	200 A~250 A	3P	ISSLFX0078	690.00
		4P	ISSLFX0079	1000.00
HID 1	80 A~100 A	1P	ISSLHX4273	80.00
	125 A~160 A	1P	ISSLHX4274	105.00
	80 A~100 A	2P	ISSLHX4275	160.00
	125 A~160 A	2P	ISSLHX4276	210.00
	80 A~100 A	3P	ISSLHX4277	240.00
	125 A~160 A	3P	ISSLHX4278	320.00
	80 A~100 A	4P	ISSLHX4279	345.00
	125 A~160 A	4P	ISSLHX4280	455.00

Enclosures for MCCBs

HSN Code: 8538

Sl.No.	Description	Item Code	Per Unit LP (₹)
1.	'ML' Frame TP	IHEMTP	2050.00
2.	'G' Frame TP	IHEGTP	
3.	'G' Frame FP	IHEGFP	
4.	'A' Frame TP	IHEATP	2355.00
5.	'A' Frame FP	IHEAFP	
6.	'F' Frame TP	IHEFTP	
7.	'F' Frame FP	IHEFFP	2480.00
8.	'L' Frame TP	IHELTP	
9.	'L' Frame FP	IHELFP	
10.	HID 1 Frame TP	ISSBOU1117	2210.00
11.	HID 1 Frame FP	ISSBOU1118	



Loadline Moulded Case Circuit Breakers

(Conforms to IS/IEC:60947-2)

Loadline Moulded Case Circuit Breakers Accessories

HSN Code: 8538

Description	'G' / 'ML' Frame		'A' Frame		HID 1 Frame		'L' Frame		'F' Frame	
	Item Code	Per Unit LP (₹)	Item Code	Per Unit LP (₹)	Item Code	Per Unit LP (₹)	Item Code	Per Unit LP (₹)	Item Code	Per Unit LP (₹)
Shunt Trip										
100 Vac - 110 Vac	IHLGS110	1165.00	IHLAS110	1700.00	ISSLEU0438	1700.00	IHLLS110	2380.00	IHLLSTF110	1700.00
220 Vac - 240 Vac	IHLGS240		IHLAS240		ISSLEU0439		IHLLS240		IHLLSTF240	
380 Vac - 415 Vac	IHLGS415		IHLAS415		ISSLEU0440		IHLLS415		IHLLSTF415	
Under Voltage Release										
110 Vac - 120 Vac	IHLGU110	1765.00	IHLAU110	2610.00	-	-	IHLLU110	3245.00	IHLUVRF110	2610.00
220 Vac - 240Vac	IHLGU240		IHLAU240		-	-	IHLLU240		IHLUVRF240	
380 Vac - 440 Vac	IHLGU440		IHLAU440		-	-	IHLLU415		IHLUVRF440	
Auxiliary Contact (250Vac/250Vdc) (450Vac/250Vdc)										
1-Changeover	IHLAS-G1CO	790.00	IHLAA1CO	865.00	ISSLEU0444	865.00	IHLLA1CO	1000.00	IHLASF1CO	945.00
2-Changeover	IHLAS-G2CO	1260.00	IHLAA2CO	1445.00	ISSLEU0445	1445.00	IHLLA2CO	1735.00	IHLASF2CO	1445.00
Rotary Handle										
Direct mounting	IHLGD000	1195.00	IHLAD000	1575.00						
Door Mounting	IHLGRN30	1490.00	IHLARN30	2050.00	ISSLEU0494	1805.00	IHLRN30	3035.00	IHLRRHF30	2050.00
Padl Lock Device										
	IHLDPG125	120.00	IHLDPA250	180.00	ISSLEU0448	355.00	IHLPP000	415.00	IHLDPF250	250.00
Trip Alarm Contact (Factory Fitted)	IHLALG1CO	790.00	IHLALA-1CO	865.00	ISSLEU0447	865.00	IHLB000	1000.00	IHLALF1CO	945.00
Auxiliary Contact + Alram Switch (Factory fitted)								ISSLEU1772	1735.00	

Earth Fault Relay for MCCBs

HSN Code: 8538

Sl. No.	MCCBs Current Range (A)	Item Code**	Per Unit LP (₹)
1	25 A- 100 A	IHEF1100	7310.00
2	125 A- 200 A	IHEF2200	8295.00
3	250 A- 400 A	IHEF3400	9680.00
4	500 A- 800 A	IHEF4800	12070.00



- The above prices are inclusive of CBCT.

** For operating the Earth Fault Relay a Shunt trip or an UVR has to be used.

Note : For operating Shunt Trip for G Frame, a separate auxiliary switch would be required in which case one c/o. will be used with the shunt trip, leaving one c/o. free for use. Door mounting clamps for G & AA Frame are supplied free of cost on request basis.



SOLUTION FROM POWER TO FINAL DISTRIBUTION

Full Range of mounting & wiring accessories with Communication architecture



MCB

'C' Series MCB

(In accordance with IS/IEC 60898-1 & IS/IEC 60947-2) 240 V/415 V, 50 Hz, 10 kA

HSN Code - 8536



Rating	SP Cat. No.	List Price in ₹ Per Unit	SPN Cat. No.	List Price in ₹ Per Unit	DP Cat. No	List Price in ₹ Per Unit
0.5 A-5 A	DHMZCSPF0x5-005	501.00	DHMZCSNF0x5-005	1107.00	DHMZCDPF0x5-005	1301.00
6 A-32 A	DHMZCSPF006-032	296.00	DHMZCSNF006-032	955.00	DHMZCDPF006-032	976.00
40 A	DHMZCSPF040	688.00	DHMZCSNF040	1423.00	DHMZCDPF040	1519.00
50 A	DHMZCSPF050	760.00	DHMZCSNF050	1514.00	DHMZCDPF050	1647.00
63 A	DHMZCSPF063	760.00	DHMZCSNF063	1514.00	DHMZCDPF063	1647.00
Rating	TP Cat. No.	List Price in ₹ Per Unit	TPN Cat. No.	List Price in ₹ Per Unit	FP Cat. No	List Price in ₹ Per Unit
0.5 A-5 A	DHMZCTPF0x5-005	1656.00	DHMZCTNF0x5-005	2422.00	DHMZCFPF0x5-005	2581.00
6 A-32 A	DHMZCTPF006-032	1543.00	DHMZCTNF006-032	2134.00	DHMZCFPF006-032	2219.00
40 A	DHMZCTPF040	2246.00	DHMZCTNF040	2956.00	DHMZGCFPF040	2987.00
50 A	DHMZCTPF050	2353.00	DHMZCTNF050	3002.00	DHMZCFPF050	3108.00
63 A	DHMZCTPF063	2353.00	DHMZCTNF063	3002.00	DHMZCFPF063	3108.00

'D' Series MCB

(In accordance with IEC 60898-1) 240 V/415 V, 50 Hz Suitable for high inrush current loads.

*Prices available on demand.



'DC' Series MCB

(In accordance with IEC 60947-2) suitable for 500 V DC Application.

HSN Code - 8536

CODE	DESCRIPTION	List Price in ₹ Per Unit
DHMZEDPF016	16 A DP C MCB ST^Dx DC	1090.00
DHMZEDPF032	32 A DP C MCB ST^Dx DC	1090.00

Higher Rating MCB (80 A to 125 A) 'C' Series,
(In accordance with IEC 60947-2) 240 V/415 V, 50 Hz, 10 kA

HSN Code - 8536



Rating	SP Cat. No.	List Price in ₹ Per Unit	DP Cat. No	List Price in ₹ Per Unit
80 A	DHMJCSPF080	2476.00	DHMJCDF080	5386.00
100 A	DHMJCSPF100	2774.00	DHMJCDF100	5532.00
125 A	DHMJCSPF125	3041.00	DHMJCDF125	6321.00
Rating	TP Cat. No.	List Price in ₹ Per Unit	FP Cat. No	List Price in ₹ Per Unit
80 A	DHMJCTPF080	7866.00	DHMJCFF080	9440.00
100 A	DHMJCTPF100	8278.00	DHMJCFF100	10312.00
125 A	DHMJCTPF125	9312.00	DHMJCFF125	10946.00

RCCB

RCCB - 'AC' Type

(In accordance with IS 12640-1 & IEC 61008-1) 240 V/415 V, 50 Hz with 10 kA short circuit withstand capacity

HSN Code - 8536



Rating (DP)	30 mA Cat. No.	List Price in ₹ Per Unit	100 mA Cat. No.	List Price in ₹ Per Unit	300 mA Cat. No.	List Price in ₹ Per Unit
16 A	DHRZCMDf030016	3898.00	DHRZCMDf100016	3810.00	DHRZCMDf300016	3920.00
25 A	DHRZCMDf030025	3898.00	DHRZCMDf100025	3810.00	DHRZCMDf300025	3920.00
32 A	DHRZCMDf030032	3927.00	DHRZCMDf100032	3884.00	DHRZCMDf300032	4041.00
40 A	DHRZCMDf030040	3927.00	DHRZCMDf100040	3884.00	DHRZCMDf300040	4041.00
63 A	DHRZCMDf030063	5144.00	DHRZCMDf100063	5144.00	DHRZCMDf300063	5294.00
80 A	DHRZCMDf030080	8257.00	DHRZCMDf100080	8257.00	DHRZCMDf300080	8256.00
100 A	DHRZCMDf030100	8383.00	DHRZCMDf100100	8383.00	DHRZCMDf300100	8256.00
Rating (FP)	30 mA Cat. No.	List Price in ₹ Per Unit	100 mA Cat. No.	List Price in ₹ Per Unit	300 mA Cat. No.	List Price in ₹ Per Unit
16 A	DHRZCMFF030016	4860.00	DHRZCMFF100016	4701.00	DHRZCMFF300016	4840.00
25 A	DHRZCMFF030025	4860.00	DHRZCMFF100025	4701.00	DHRZCMFF300025	4840.00
32 A	DHRZCMFF030032	4896.00	DHRZCMFF100032	4788.00	DHRZCMFF300032	4929.00
40 A	DHRZCMFF030040	4896.00	DHRZCMFF100040	4788.00	DHRZCMFF300040	4929.00
63 A	DHRZCMFF030063	5156.00	DHRZCMFF100063	5156.00	DHRZCMFF300063	5307.00
80 A	DHRZCMFF030080	8670.00	DHRZCMFF100080	8670.00	DHRZCMFF300080	8670.00
100 A	DHRZCMFF030100	8894.00	DHRZCMFF100100	8894.00	DHRZCMFF300100	8894.00

RCCB - 'A' Type

(In accordance with IS 12640-1 & IEC 61008-1) 240 V/415 V, 50 Hz with 10 kA short circuit withstand capacity

HSN Code - 8536



Rating (DP)	30 mA Cat. No.	List Price in ₹ Per Unit	100 mA Cat. No.	List Price in ₹ Per Unit	300 mA Cat. No.	List Price in ₹ Per Unit
25 A	DHRZAMDF030025	4943.00	DHRZAMDF100025	4773.00	DHRZAMDF300025	4773.00
40 A	DHRZAMDF030040	5300.00	DHRZAMDF100040	5084.00	DHRZAMDF300040	5084.00
63 A	DHRZAMDF030063	6250.00	DHRZAMDF100063	6055.00	DHRZAMDF300063	6055.00
Rating (FP)	30 mA Cat. No.	List Price in ₹ Per Unit	100 mA Cat. No.	List Price in ₹ Per Unit	300 mA Cat. No.	List Price in ₹ Per Unit
25 A	DHRZAMFF030025	5782.00	DHRZAMFF100025	5770.00	DHRZAMFF300025	5770.00
40 A	DHRZAMFF030040	5865.00	DHRZAMFF100040	5856.00	DHRZAMFF300040	5856.00
63 A	DHRZAMFF030063	6165.00	DHRZAMFF100063	6241.00	DHRZAMFF300063	6241.00

ARC FAULT DETECTION DEVICE (AFDD)



Arc Fault Detection Device (AFDD)

HSN Code - 8536

CODE	DESCRIPTION	List Price in ₹ Per Unit
DHAZINSNF016	16 A Combined 1P+N MCB + AFDD	₹ 12800.00
DHAZINSNF032	32 A Combined 1P+N MCB + AFDD	₹ 12800.00
DHAZCNSNF016	16 A Combined 1P+N RCBO + AFDD	₹ 16000.00
DHAZCNSNF032	32 A Combined 1P+N RCBO + AFDD	₹ 16000.00

SUPPORT MODULES



Auxiliary Contact For MCB & RCCB

In accordance with IS/IEC 60947-5-1, 240 V, 50 Hz

HSN Code - 8536

CODE	DESCRIPTION	List Price in ₹ Per Unit
DHMAHSPF006	1NO + 1NC (MCB)	822.00
DHRAHSPF006	1NO + 1NC (RCCB)	822.00



Shunt Trip For MCB

In accordance with IS/IEC 60947-3-1, 240 V, 50 Hz

HSN Code - 8536

CODE	RATING	List Price in ₹ Per Unit
DHMZNP1X0002110	12 V	1606.00
DHMZNP1X0002200	24 V	1606.00
DHMZNP1X0002310	48 V	1606.00
DHMZNP1X0002400	240 V	1606.00

Under Voltage/Over Voltage For MCB

HSN Code - 8536



CODE	DESCRIPTION	List Price in ₹ Per Unit
DHMZNP1X0003510	OVT HGD63H Option Single Phase	1477.00
DHMZNP3X0003510	OVT HGD63H Option Three Phase	3640.00
DHMZNP1X0003110	UVT Single Phase 240 Vac	1477.00
DHMZNP1X0004110	UVT-OVT 1 Phase 240 Vac	1698.00
DHMZNP3X0004110	UVT-OVT 3 Phase 240 Vac	4029.00
DHMZNP1X0003210	UVT delay 1 Phase 240 Vac	1627.00
DHMZNP3X0003210	UVT delay 3 Phase 240 Vac	3797.00

RCBO

RCBO is designed for use in domestic, commercial and industrial distribution systems at the most downstream circuit for ensuring protection from leakage current, short circuit & over load to the user for a particular circuit. In normal use, it is safe to use and free of threat to user as well as to environment.



Electromechanical 2 P RCBOs used as (SPN & 2 P RCBOs)
(In accordance with IS 12640-2 & IEC 61009-1) 240 V/415 V, 50 Hz, with 10 kA short circuit capacity

HSN Code - 8536

Rating (SPN)	30 mA Cat. No.	List Price in ₹ Per Unit	100 mA Cat. No.	List Price in ₹ Per Unit	300 mA Cat. No.	List Price in ₹ Per Unit
16 A	DHBMACDP4030016	4713.00	DHBMACDP4100016	5102.00	DHBMACDP4300016	5544.00
25 A	DHBMACDP4030025	4713.00	DHBMACDP4100025	5102.00	DHBMACDP4300025	5544.00
32 A	DHBMACDP4030032	4851.00	DHBMACDP4100032	5241.00	DHBMACDP4300032	5685.00
40 A	DHBMACDP4030040	5338.00	DHBMACDP4100040	5961.00	DHBMACDP4300040	6446.00
63 A	DHBMACDP4030063	6550.00	DHBMACDP4100063	6898.00	DHBMACDP4300063	7243.00

Electromechanical 4P RCBOs used as (TPN & FP RCBOs)
(In accordance with IS 12640-2 & IEC 61009-1) 240 V/415 V, 50 Hz, with 10 kA short circuit capacity

HSN Code - 8536

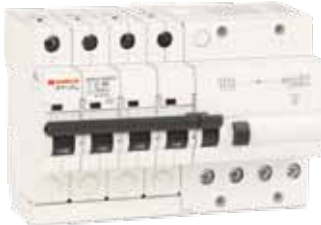

Rating (TPN)	30 mA Cat. No.	List Price in ₹ Per Unit	100 mA Cat. No.	List Price in ₹ Per Unit	300 mA Cat. No.	List Price in ₹ Per Unit
16 A	DHBMACTN8030016	5961.00	DHBMACTN8100016	6411.00	DHBMACTN8300016	6690.00
25 A	DHBMACTN8030025	5961.00	DHBMACTN8100025	6411.00	DHBMACTN8300025	6690.00
32 A	DHBMACTN8030032	6100.00	DHBMACTN8100032	6550.00	DHBMACTN8300032	6828.00
40 A	DHBMACTN8030040	6170.00	DHBMACTN8100040	6919.00	DHBMACTN8300040	7277.00
63 A	DHBMACTN8030063	7348.00	DHBMACTN8100063	7668.00	DHBMACTN8300063	7668.00

RCBO - A Type (SPN - 2 M)
(In accordance with IS 12640-2 & IEC 61009-1) 240 V/415 V, 50 Hz, with 10 kA short circuit capacity

HSN Code - 8536



Rating (SPN)	30 mA Cat. No.	100 mA Cat. No.	300 mA Cat. No.	List Price in ₹ Per Unit
6 A	DHCEACSN2030006	DHCEACSN2100006	DHCEACSN2300006	4567.00
10 A	DHCEACSN2030010	DHCEACSN2100010	DHCEACSN2300010	4567.00
16 A	DHCEACSN2030016	DHCEACSN2100016	DHCEACSN2300016	4567.00
20 A	DHCEACSN2030020	DHCEACSN2100020	DHCEACSN2300020	4567.00
25 A	DHCEACSN2030025	DHCEACSN2100025	DHCEACSN2300025	4567.00
32 A	DHCEACSN2030032	DHCEACSN2100032	DHCEACSN2300032	4567.00
40 A	DHCEACSN2030040	DHCEACSN2100040	DHCEACSN2300040	5629.00

SPD



Surge Protection Adaptor Type 3

HSN Code - 8536

Order Code	Description	List Price in ₹ Per Unit
DHAA3NMA10230	Surge Protection Adaptor Type 3 SPD	1158.00



Type 1+2 AC Surge Protection Device

HSN Code - 8536

Order Code	Poles	Uc (V)	In (kA)	Iimp (kA)	Imax (kA)	Up (kV)	Remote Signaling	List Price in ₹ Per Unit
DHSAANBC50320	TP+N	320 V	20 kA	12.5 kA	50 kA	1.5 kV	No	14353.00
DHSAANAC50320	1P+N	320 V	20 kA	12.5 kA	50 kA	1.5 kV	No	7812.00
DHSAARBC50320	TP+N	320 V	20 kA	12.5 kA	50 kA	1.5 kV	Yes	14671.00
DHSAARAC50320	1P+N	320 V	20 kA	12.5 kA	50 kA	1.5 kV	Yes	8138.00

Cartridges

HSN Code - 8536

Order Code	Pole	Uc (V)	In (kA)	Iimp (kA)	Imax (kA)	Up (kV)	List Price in ₹ Per Unit
DSSRCX0149	L - N	320 V	20 kA	12.5 kA	50 kA	1.5 kV	₹ 3649.00
DSSRCX0150	N - PE	255 V	40 kA	12.5 kA	70 kA	1.5 kV	₹ 4478.00



Type 2 AC Surge Protection Device

HSN Code - 8536

Order Code	Poles	Uc (V)	In (kA)	Imax (kA)	Up (kV)	Remote Signaling	List Price in ₹ Per Unit
DHSA2N1N40320	1P	320 V	20 kA	40 kA	1.5 kV	No	1530.00
DHSA2N1N40275	1P	275 V	20 kA	40 kA	1.3 kV	No	1530.00
DHSA2NAN40320	1P+N	320 V	20 kA	40 kA	1.5 kV	No	2555.00
DHSA2NAN40275	1P+N	275 V	20 kA	40 kA	1.3 kV	No	2555.00
DHSA2NBN40320	TP+N	320 V	20 kA	40 kA	1.5 kV	No	4185.00
DHSA2NBN40275	TP+N	275 V	20 kA	40 kA	1.3 kV	No	4185.00
DHSA2R1N40320	1P	320 V	20 kA	40 kA	1.5 kV	Yes	1695.00
DHSA2R1N40275	1P	275 V	20 kA	40 kA	1.3 kV	Yes	1695.00
DHSA2RAN40320	1P+N	320 V	20 kA	40 kA	1.5 kV	Yes	2720.00
DHSA2RAN40275	1P+N	275 V	20 kA	40 kA	1.3 kV	Yes	2720.00
DHSA2RBN40320	TP+N	320 V	20 kA	40 kA	1.5 kV	Yes	4350.00
DHSA2RBN40275	TP+N	275 V	20 kA	40 kA	1.3 kV	Yes	4350.00

Cartridges

HSN Code - 8536

Order Code	Pole	Uc (V)	In (kA)	Imax (kA)	Up (kV)	List Price in ₹ Per Unit
DSSRCX0151	L - N	320 V	20 kA	40 kA	1.5 kV	963.00
DSSRCX0152	L - N	275 V	20 kA	40 kA	1.3 kV	963.00
DSSRCX0153	N - PE	255 V	20 kA	40 kA	1.5 kV	1284.00



Type 1+2 Photovoltaic Surge Protection Device

HSN Code - 8535

Order Code	Uc _{pv} (V)	In (kA)	Iimp (kA)	Imax (kA)	Up (kV)	Remote Signaling	List Price in ₹ Per Unit
DHSDANCC6012H	1200 Vdc	20 kA	12.5 kA	60 kA	4 kV	No	14818.00
DHSDARCC6012H	1200 Vdc	20 kA	12.5 kA	60 kA	4 kV	Yes	15128.00
DHSDANCB4012H	1200 Vdc	20 kA	6 kA	40 kA	4 kV	No	7851.00
DHSDARCB4012H	1200 Vdc	20 kA	6 kA	40 kA	4 kV	Yes	8161.00

Cartridges

HSN Code - 8536

Order Code	Pole	Uc _{pv} (V)	In (kA)	Iimp (kA)	Imax (kA)	Up (kV)	List Price in ₹ Per Unit
DSSRCX0154	-	1200 Vdc	20 kA	6 kA	40 kA	4 kV	3500.00



Type 2 Photovoltaic Surge Protection Device

HSN Code - 8535

Order Code	Ucpv (V)	In (kA)	I _{max} (kA)	Up (kV)	Remote Signaling	List Price in ₹ Per Unit
DHSD2NCN4012H	1200 Vdc	20 kA	40 kA	4 kV	No	2600.00
DHSD2RCN4012H	1200 Vdc	20 kA	40 kA	4 kV	Yes	2770.00
DHSD2N2N40600	600 Vdc	20 kA	40 kA	4 kV	No	2200.00

Cartridges

HSN Code - 8536

Order Code	Pole	Ucpv (V)	In (kA)	I _{max} (kA)	Up (kV)	List Price in ₹ Per Unit
DSSRCX0155	-	1200 Vdc	20 kA	40 kA	4 kV	749.00



Dataline Surge Protection Device

HSN Code - 8536

Order Code	Un (V)	In (kA)	I _{imp} (kA)	I _{max} (kA)	Up (V)	Remote Signaling	List Price in ₹ Per Unit
DHSDDN1A20006	6 V	5 kA	5 kA	20 kA	20 kV	No	2215.00
DHSDDN1A20012	12 V	5 kA	5 kA	20 kA	30 kV	No	2215.00
DHSDDN1A20024	24 V	5 kA	5 kA	20 kA	40 kV	No	2365.00
DHSDDN1A20048	48 V	5 kA	5 kA	20 kA	70 kV	No	2365.00

* Spare Cartridges Available on Request.

TIME SWITCH

Time switches are used in residential, commercial and industrial premises to improve comfort and save energy by switching loads automatically as per real time. Havells offers a variety of time switches to precisely meet the requirements of different applications. The range offers several feature benefits such as different options of minimum switching time, internal battery to enable the timing function in case of power failure, daily and weekly versions, simple and compact design.



Time Switch

HSN Code - 9107

Description	Cat. No.	List Price in ₹ Per Unit
24 Hour Analog Time Switch (SST* - 15 min)	DHTED15016	3509.00
24 Hour Analog Time Switch (SST* - 30 min)	DHTED30016	3173.00
Astronomical + Digital Time Switch-3 years	DHTQB01016	3639.00
Digital Weekly Time Switch-3 years	DHTJW01016	3367.00
Multifunction Time Switch-10 years	DHTLB01016	6334.00
Twilight Time Switch	DHTPNN025	3268.00
Staircase Time Switch-3 years	DHTMNX5016	1839.00

* Shortest Switching Time

ACCL

3 Module SPN ACCL (Automatic Source Changeover with Current Limiter)

HSN Code - 8536



Mains Rating	Gen Rating	Product Code	Description	List Price in ₹ Per Unit
SPN 30 (6000 W)	SPN 1.5 (300 W)	DHADOSN301X	30 A/1.5 A ACCL W/O GEN START/STOP	2244.00
SPN 30 (6000 W)	SPN 2.5 (500 W)	DHADOSN302X	30 A/2.5 A ACCL W/O GEN START/STOP	2244.00
SPN 30 (6000 W)	SPN 3 (600 W)	DHADOSN3003	30 A/03 A ACCL W/O GEN START/STOP	2244.00
SPN 30 (6000 W)	SPN 4 (800 W)	DHADOSN3004	30 A/04 A ACCL W/O GEN START/STOP	2244.00
SPN 30 (6000 W)	SPN 5 (1000 W)	DHADOSN3005	30 A/05 A ACCL W/O GEN START/STOP	2244.00
SPN 30 (6000 W)	SPN 6 (1200 W)	DHADOSN3006	30 A/06 A ACCL W/O GEN START/STOP	2244.00
SPN 30 (6000 W)	SPN 9 (1800 W)	DHADOSN3009	30 A/09 A ACCL W/O GEN START/STOP	2244.00
SPN 30 (6000 W)	SPN 12 (2400 W)	DHADOSN3012	30 A/12 A ACCL W/O GEN START/STOP	2244.00
SPN 30 (6000 W)	SPN 15 (3000 W)	DHADOSN3015	30 A/15 A ACCL W/O GEN START/STOP	2244.00
SPN 30 (6000 W)	SPN 20 (4000 W)	DHADOSN3020	30 A/20 A ACCL W/O GEN START/STOP	2244.00

MCB Isolator



MCB ISOLATOR (Switching Devices)
MCB Isolators (AC-22 A, In accordance with IS/IEC 60947-3) 240 V/415 V, 50 Hz

HSN Code - 8536

Rating	SP Cat. No.	List Price in ₹ Per Unit	DP Cat. No.	List Price in ₹ Per Unit
40 A	-	-	DHMZIDPX040	584.00
63 A	-	-	DHMZIDPX063	757.00
80 A	-	-	DHMZIDPX080	1029.00
100 A	-	-	DHMZIDPX100	1041.00
125 A	-	-	DHMZIDPX125	1124.00
Rating	TP Cat. No.	List Price in ₹ Per Unit	FP Cat. No.	List Price in ₹ Per Unit
40 A	DHMZITPX040	1248.00	DHMZIFPX040	1376.00
63 A	DHMZITPX063	1413.00	DHMZIFPX063	1392.00
80 A	DHMZITPX080	1670.00	DHMZIFPX080	1827.00
100 A	DHMZITPX100	1682.00	DHMZIFPX100	1840.00
125 A	DHMZITPX125	1716.00	DHMZIFPX125	2025.00

Industrial Plug



Industrial Plug

HSN Code - 8536

Rating	Poles	Code	Type	Earth-Contact position	Std. / Master Packing (No. of Unit/s)	List Price in ₹ Per Unit
16 A	2P+E	DHQBA63016	IP44	6h	4 N	499.00
32 A	2P+E	DHQBA63032	IP44	6h	4 N	701.00
16 A	3P+N+E	DHQBA65016	IP44	6h	4 N	608.00
32 A	3P+N+E	DHQBA65032	IP44	6h	4 N	905.00
16 A	2P+E	DHQBB63016	IP67	6h	4 N	855.00
32 A	2P+E	DHQBB63032	IP67	6h	4 N	1349.00
16 A	3P+N+E	DHQBB65016	IP67	6h	4 N	1170.00
32 A	3P+N+E	DHQBB65032	IP67	6h	2 N	1398.00
63 A	3P+N+E	DHQBB65063	IP67	6h	1 N	3555.00

Industrial Connector



Industrial Connector

HSN Code - 8536

Rating	Poles	Code	Type	Earth-Contact position	Std. / Master Packing (No. of Unit/s)	List Price in ₹ Per Unit
16 A	2P+E	DHQDA63016	IP44	6h	4 N	656.00
32 A	2P+E	DHQDA63032	IP44	6h	4 N	829.00
16 A	3P+N+E	DHQDA65016	IP44	6h	4 N	785.00
32 A	3P+N+E	DHQDA65032	IP44	6h	4 N	1057.00
16 A	2P+E	DHQDB63016	IP67	6h	4 N	1155.00
32 A	2P+E	DHQDB63032	IP67	6h	4 N	1613.00
16 A	3P+N+E	DHQDB65016	IP67	6h	4 N	1543.00
32 A	3P+N+E	DHQDB65032	IP67	6h	2 N	1813.00
63 A	3P+N+E	DHQDB65063	IP67	6h	1 N	4131.00

Panel Socket



Industrial Panel Socket

HSN Code - 8536

Rating	Poles	Code	Type	Earth-Contact position	Std. / Master Packing (No. of Unit/s)	List Price in ₹ Per Unit
16 A	2P+E	DHQCA63016	IP44	6h	6 N	457.00
32 A	2P+E	DHQCA63032	IP44	6h	4 N	791.00
16 A	3P+N+E	DHQCA65016	IP44	6h	4 N	744.00
32 A	3P+N+E	DHQCA65032	IP44	6h	4 N	900.00
16 A	2P+E	DHQCB63016	IP67	6h	4 N	914.00
32 A	2P+E	DHQCB63032	IP67	6h	4 N	1070.00
16 A	3P+N+E	DHQCB65016	IP67	6h	4 N	1065.00
32 A	3P+N+E	DHQCB65032	IP67	6h	3 N	1393.00
63 A	3P+N+E	DHQCB65063	IP67	6h	1 N	3710.00

Interlocking Socket



Industrial Interlocking Socket

HSN Code - 8536

Rating	Poles	Code	Type	Earth-Contact position	Std. / Master Packing (No. of Unit/s)	List Price in ₹ Per Unit
16 A	2P+E	DHQIA63016	IP44	6h	1 N	6376.00
32 A	3P+N+E	DHQIA65032	IP44	6h	1 N	9651.00
16 A	2P+E	DHQWB63016	IP67	6h	1 N	6585.00
32 A	3P+N+E	DHQWB65032	IP67	6h	1 N	10270.00

Solution with Insulated Plug & Socket



Solution with Insulated Plug & Socket

HSN Code - 8536

Rating	Poles	Code	MCB Module Available	Earth-Contact position	Std. / Master Packing (No. of Unit/s)	List Price in ₹ Per Unit
16 A	2P+E	DHDPBDP016	2	6h	1 N	1815.00
16 A	3P+N+E	DHDPBTN016	4	6h	1 N	2189.00
32 A	2P+E	DHDPBDP032	2	6h	1 N	2485.00
32 A	3P+N+E	DHDPBTN032	4	6h	1 N	2807.00
32 A	3P+N+E	DHDPBEN032	8	6h	1 N	3594.00
63 A	3P+N+E	DHDPBEN063	8	6h	1 N	9294.00

Note: MCB to be bought separately.

'G' Frame Panel Boards, O/G TP MCCBs G-Frame HSN Code: 8537

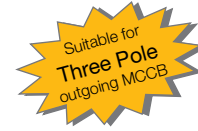

Incomer**	Outgoing* (No. of Ways)	Single Door Item Code	Per Unit LP (₹)	Double Door Item Code	Per Unit LP (₹)
250 A "AA" Frame MCCB	2	IHVG025002	41245.00	IHVG02500200	45060.00
	4	IHVG025004	51815.00	IHVG02500400	55580.00
	6	IHVG025006	59300.00	IHVG02500600	63090.00
	8	IHVG025008	64210.00	IHVG02500800	68000.00
	12	IHVG025012	79290.00	IHVG02501200	83020.00
	16	IHVG025016	93290.00	IHVG02501600	97080.00
400 A "LS" Frame MCCB	2	IHLG040002	48180.00	IHLG04000200	52650.00
	4	IHLG040004	57535.00	IHLG04000400	61720.00
	6	IHLG040006	61245.00	IHLG04000600	65165.00
	8	IHLG040008	65425.00	IHLG04000800	69290.00
	12	IHLG040012	84280.00	IHLG04001200	88230.00
	16	IHLG040016	100080.00	IHLG04001600	104155.00

Single door



* The outgoings number of ways is the number of "G" Frame TP MCCBs that can be mounted. In case of SP MCCBs the number of MCCBs shall be three times the number of ways in TP MCCBs.
** Maximum ratings are indicated for the incoming MCCBs however lower ratings in the same frame can be ordered.
The above prices are for bare enclosures only, incoming and outgoing MCCBs have to be ordered separately.

'G' Frame Panel Boards, O/G FP MCCBs G-Frame HSN Code: 8537

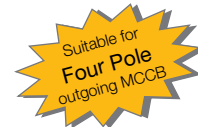

Incomer**	Outgoing* (No. of Ways)	Single Door Item Code	Per Unit LP (₹)	Double Door Item Code	Per Unit LP (₹)
250 A "AA" Frame MCCB	2	IHVGF25002	44395.00	IHVGF2500200	48130.00
	4	IHVGF25004	55215.00	IHVGF2500400	58990.00
	6	IHVGF25006	65015.00	IHVGF2500600	68745.00
	8	IHVGF25008	70165.00	IHVGF2500800	73940.00
	12	IHVGF25012	101785.00	IHVGF2501200	105550.00
400 A "LS" Frame MCCB	2	IHLGF40002	51860.00	IHLGF4000200	56235.00
	4	IHLGF40004	61315.00	IHLGF4000400	65490.00
	6	IHLGF40006	67140.00	IHLGF4000600	71000.00
	8	IHLGF40008	71490.00	IHLGF4000800	75350.00
	12	IHLGF40012	108175.00	IHLGF4001200	112180.00

* The outgoings number of ways is the number of "G" Frame FP MCCBs that can be mounted. In case of SP MCCBs the number of MCCBs shall be four times the number of way in FP O/G MCCBs.
** Maximum ratings are indicated for the incoming MCCBs however lower ratings in the same frame can be ordered.
Outgoing spreader link for MCCB are available on request.
The above prices are for bare enclosures only, incoming and outgoing MCCBs have to be ordered separately.

Accessories : Cable Alley for 'G' / 'A' Frame Panel Boards - Outgoing TP MCCB,

Incomer 'A' & 'L' Frame MCCB

HSN Code: 8537

Sl. No.	Description*	Single Door Item Code	Per Unit LP (₹)	Double Door Item Code	Per Unit LP (₹)
1	Cable Alley I/C 250 A,O/G 3P GF 2/4Way	ISSBOU0674	15995.00	ISSBOU0690	17150.00
2	Cable Alley I/C 250 A,O/G 3P GF 6WAY & 4P 2/4Way	ISSBOU0675	21475.00	ISSBOU0691	22640.00
3	Cable Alley I/C 250 A,O/G 3P GF 8WAY & 4P 6Way	ISSBOU0676	21770.00	ISSBOU0692	23745.00
4	Cable Alley I/C 250 A,O/G 3P GF 12Way	ISSBOU0677	24695.00	ISSBOU0693	25380.00
5	Cable Alley I/C 250 A,O/G 4P GF 8Way	ISSBOU0678	24695.00	ISSBOU0694	25380.00
6	Cable Alley I/C 250 A,O/G 3P GF 16Way & 4P 12Way	ISSBOU0679	29090.00	ISSBOU0696	30190.00
7	Cable Alley I/C 400 A,O/G 3P GF 2/4Way	ISSBOU0680	18935.00	ISSBOU0697	19620.00
8	Cable Alley I/C 400 A,O/G 3P GF 6WAY & 4P 2/4Way	ISSBOU0681	18935.00	ISSBOU0698	19620.00
9	Cable Alley I/C 400 A/630 A, O/G 3P GF 8Way, 4P 6Way & A/F 6Way	ISSBOU0682	25460.00	ISSBOU0699	26695.00
10	Cable Alley I/C 400 A,O/G 3P GF 12Way	ISSBOU0683	29380.00	ISSBOU0700	30190.00
11	Cable Alley I/C 400 A/630 A, O/G 4P GF 8Way & TP A/F 8Way	ISSBOU0684	30880.00	ISSBOU0701	31560.00
12	Cable Alley I/C 400 A/630, O/G 4P GF 12Way, TP GF 16Way & TP A/F 12Way	ISSBOU0685	32250.00	ISSBOU0702	32935.00

* Each set of Cable Alley consists of two numbers, one each on LHS and RHS.

'A' Frame Panel Boards, O/G TP MCCBs

HSN Code: 8537

Incomer**	Outgoing* (No. of Ways)	Single Door Item Code	Per Unit LP (₹)	Double Door Item Code	Per Unit LP (₹)
400 A "LS" Frame MCCB	6	IHLA040006	83090.00	IHLA04000600	86115.00
	8	IHLA040008	88755.00	IHLA04000800	91860.00
	12	IHLA040012	114320.00	IHLA04001200	117285.00
630 A "L" Frame MCCB	6	IHLA063006	91340.00	IHLA06300600	96370.00
	8	IHLA063008	97340.00	IHLA06300800	100955.00
	12	IHLA063012	115650.00	IHLA06301200	130520.00

Double door



* The outgoings number of ways is the number of "A" Frame TP MCCBs that can be mounted.

** Maximum ratings are indicated for the incoming MCCBs however lower ratings in the same frame can be ordered. Outgoing spreader link for MCCB are available on request.

The above prices are for bare enclosures only, incoming and outgoing MCCBs have to be ordered separately.

Terminal for G & A Frame Outgoing

S. No.	Description	Item Code	Per Unit LP (₹)
1	Terminal for G Frame Outgoing (Per Pole)	ISCCUPBOP151	115.00
2	Terminal for A Frame Outgoing (Per Pole)	ISCCUPBOP167	295.00

Pre-Wired Meter Module with Voltmeter, Ammeter, Selector Switch, Ct's Control Fuse & Indicating Lights

S. No.	Description	Single Door Item Code	Per Unit LP (₹)	Double Door Item Code	Per Unit LP (₹)
1	Prewire Meter Module - Analog	ISSBOU0689	18525.00	ISSBOU0706	19225.00
2	Meter Module - Digital	ISSBOU0711	22780.00	ISSBOU0707	24020.00

Bare Meter Module / MCB Module / Add on Module

S. No.	Description	Single Door Item Code	Per Unit LP (₹)	Double Door Item Code	Per Unit LP (₹)
1	Meter Module - Analog Provision for Ammeter, Voltmeter - Analog with selector switch	ISSBOU0686	7135.00	ISSBOU0703	8230.00
2	MCB Module	ISSBOU0687	7135.00	ISSBOU0704	8230.00
3	Add on Module	ISSBOU0688	7135.00	ISSBOU0705	8230.00

Ammeter, Voltmeter, Selector Switch, Control Fuses, Indicating Lights, MCBs etc. have to be ordered separately and are at extra cost. The above prices are for bare module enclosures only.

Add on Incoming Changeover Switch Enclosure**

S. No.	Description	Item Code	Per Unit LP (₹)
1	250 A Incoming change Over switch-F1	ISSBOU0708	13550.00
2	400 A & 630 A Incoming change Over switch - F2	ISSBOU0709	19915.00

** The above prices are for bare module enclosures only.

Add on Incoming Changeover Switch with Enclosure

S. No.	Description	Item Code	Per Unit LP (₹)
1	250 A Incoming change Over switch-F1	ISSBOU0712	53955.00
2	400 A Incoming change Over switch - F2	ISSBOU0713	71500.00
3	630 A Incoming change Over switch - F3	ISSBOU0714	79950.00

Add on Incoming Automatic Changeover Switch with Enclosure

S. No.	Description	Item Code	Per Unit LP (₹)
1	100A ATS FITT. ENCL P.SAFE	ISSBOU1128	143195.00
2	125A ATS FITT. ENCL P.SAFE	ISSBOU1129	149895.00
3	250A ATS FITT. ENCL P.SAFE	ISSBOU1126	208635.00



Euroload (ON-Load) Changeover Switch (4 Pole) I-0-II

(Conforms to IS/IEC:60947-3)

HSN Code: 8536

Frame Size	Rating (A)	Open Execution Item Code	Per Unit LP (₹)	SS Enclosure Item Code	Per Unit LP (₹)
00	040 A	IHCNFO0040	5355.00	IHCNFE0040	7870.00
00	063 A	IHCNFO0063	5630.00	IHCNFE0063	8385.00
00	100 A	IHCNFO0100	7545.00	IHCNFE0100	10565.00
0	125 A	IHCNFO0125	11270.00	IHCNFE0125	15845.00
0	160 A	IHCNFO0160	12075.00	IHCNFE0160	16875.00
0	200 A	IHCNFO0200	14480.00	IHCNFE0200	19440.00
1	250 A	IHCNFO0250	20950.00	IHCNFE0250	26885.00
1	320 A	IHCNFO0320	22135.00	IHCNFE0320	28120.00
2	400 A	IHCNFO0400	31985.00	IHCNFE0400	41375.00
2	630 A	IHCNFO0630	38005.00	IHCNFE0630	47880.00
3	800 A	IHCNFO0800	56885.00	IHCNFE0800	72260.00
4	1000 A	IHCNFO1000	96885.00	IHCNFE1000	131705.00
4	1250 A	IHCNFO1250	128630.00	IHCNFE1250	176320.00
4	1600 A	IHCNFO1600	153185.00	IHCNFE1600	236775.00
5	2000 A	IHCNFO2000	237335.00	IHCNFE2000	311975.00
5	2500 A	IHCNFO2500	314780.00	IHCNFE2500	398300.00
5	3150 A	IHCNFO3150	430950.00	IHCNFE3150	539590.00



Note :
Phase Barriers & Handle with door interlock kit is integral part of the Changeover Switch.
Aux. contacts for signalling and electrical interlocking are optional and provided at extra price.
For motorised changeover please contact with nearest branch.

Instaprime Automatic Transfer Switch

Four Pole, AC-32B / AC - 33B*, 50 Hz, 415 V
Automatic/Manual Range

HSN Code: 8537

Rating (A)	Open Execution Item Code	Per Unit LP (₹)	Cat. no. 4 pole (Close Execution)	Per Unit LP (₹)
40 A	IHRFBAO040	24605.00	IHRFBAE040	26670.00
63 A	IHRFBAO063	25725.00	IHRFBAE063	27790.00
80 A	IHRFBAO080	27000.00	IHRFBAE080	29060.00
100 A	IHRFBAO100	27915.00	IHRFBAE100	29975.00
125 A	IHRFBAO125	31615.00	IHRFBAE125	33675.00

* Up to 80 A



Instaline Automatic Transfer Switch

Four Pole, AC-31A, 50 Hz, 415 V
Automatic/Manual with complete protection

HSN Code: 8537

Rating A	Item Code 4P	Per Unit LP (₹)	Item Code 4P	Per Unit LP (₹)
	Open Execution		With Enclosure	
100 A	IHYFCDO100	51480.00	IHYFCDE100	62910.00
125 A	IHYFCDO125	55225.00	IHYFCDE125	66120.00
160 A	IHYFCDO160	60955.00	IHYFCDE160	72715.00
200 A	IHYFCDO200	77150.00	IHYFCDE200	88890.00
250 A	IHYFCDO250	86530.00	IHYFCDE250	98610.00
315 A	IHYFCDO315	90455.00	IHYFCDE315	10219.00
400 A	IHYFCDO400	103550.00	IHYFCDE400	123985.00
500 A	IHYFCDO500	120550.00	IHYFCDE500	140575.00
630 A	IHYFCDO630	132875.00	IHYFCDE630	152905.00



ATS without controller is available on request

ATS Wire Harness: HSN Code: 8537

Item Code	Per Unit LP (₹)
ISSYAX0201	3390.00

Euroload By Pass Switch

Conforms to IS:13947 (Part-3); IEC:60947-3

Four Pole, 415 V

HSN Code: 8536

Frame Size	Current Rating (A)	Open Execution Item Code	Per Unit LP (₹)
00	063 A	IHCBFO0063	10390.00
00	100 A	IHCBFO0100	12250.00
0	125 A	IHCBFO0125	15610.00
0	160 A	IHCBFO0160	18595.00
0	200 A	IHCBFO0200	19995.00
1	250 A	IHCBFO0250	28930.00
1	320 A	IHCBFO0320	30565.00
2	400 A	IHCBFO0400	44175.00
2	630 A	IHCBFO0630	52485.00
3	800 A	IHCBFO0800	78560.00
3	1000 A	IHCBFO1000	133790.00
3	1600 A	IHCBFO1600	211550.00

Accessories:

HSN Code: 8538

Aux. Contact	Item Code	Per Unit LP (₹)
1 NO. 1 NC.	IHCNFACT1CO	390.00
2 NO. 2 NC.	IHCNFACT2CO	525.00



Euroload Switch Disconnecter

(Conforms to IS/IEC:60947-3)

Three Pole, 415 V

HSN Code: 8536

Frame Size	Current Rating A	Open Execution Item Code	Per Unit LP (₹)	SS Enclosure Item Code	Per Unit LP (₹)
0	80 A	IHCSTO0080	1960.00	IHCSTE0080	3050.00
0	100 A	IHCSTO0100	2970.00	IHCSTE0100	4225.00
0	125 A	IHCSTO0125	3955.00	IHCSTE0125	5140.00
0	160 A	IHCSTO0160	4710.00	IHCSTE0160	6495.00
0	200 A	IHCSTO0200	5350.00	IHCSTE0200	6630.00
1	250 A	IHCSTO0250	6685.00	IHCSTE0250	8515.00
1	320 A	IHCSTO0320	7340.00	IHCSTE0320	9335.00
1	400 A	IHCSTO0400	10570.00	IHCSTE0400	12735.00



Euroload Switch Disconnecter

Four Pole, 415 V

HSN Code: 8536

Frame Size	Current Rating A	Open Execution Item Code	Per Unit LP (₹)	SS Enclosure Item Code	Per Unit LP (₹)
00	40 A	IHCSFO0040	1435.00	IHCSFE0040	2350.00
00	63 A	IHCSFO0063	1620.00	IHCSFE0063	2565.00
00	80 A	IHCSFO0080	2400.00	IHCSFE0080	3255.00
00	100 A	IHCSFO0100	3870.00	IHCSFE0100	4735.00
0	125 A	IHCSFO0125	4125.00	IHCSFE0125	5220.00
0	160 A	IHCSFO0160	4940.00	IHCSFE0160	6030.00
0	200 A	IHCSFO0200	5960.00	IHCSFE0200	7200.00
1	250 A	IHCSFO0250	7470.00	IHCSFE0250	9685.00
1	320 A	IHCSFO0320	8190.00	IHCSFE0320	10285.00
2	400 A	IHCSFO0400	11360.00	IHCSFE0400	14200.00
2	630 A	IHCSFO0630	13010.00	IHCSFE0630	16035.00
3	800 A	IHCSFO0800	19395.00	IHCSFE0800	22880.00
4	1000 A	IHCSFO1000	29340.00	IHCSFE1000	41565.00
4	1250 A	IHCSFO1250	44065.00	IHCSFE1250	50000.00
4	1600 A	IHCSFO1600	60640.00	IHCSFE1600	67235.00
5	2000 A	IHCSFO2000	69490.00	IHCSFE2000	88525.00
5	2500 A	IHCSFO2500	90175.00	IHCSFE2500	115870.00
5	3150 A	IHCSFO3150	127210.00	IHCSFE3150	164680.00



Kompact *plus* Switch Disconnecter Fuse

HSN Code: 8537

(Conforms to IS/IEC:60947- Part 1 & 3)

Switch Disconnecter Fuse (Panel Mounting Cubicle Type) - AC-23A, 50 Hz, 415 V
Kompact Plus



Rating A	Pole	Type of Fuse	With / Without Fuse	Item Code	Per Unit LP (₹)	Item Code	Per Unit LP (₹)	Suitable Fuse
				Open Execution		In Sheet Steel Encl.		
32 A	TPN	Bolted Type	With 3 Fuses	IHKDTF4032	2655.00	IHKDTW4032	4280.00	IHHTIA0032
63 A				IHKDTF4063	3655.00	IHKDTW4063	5295.00	IHHTSS0063
100 A				IHKDTF4100	7405.00	IHKDTW4100	8940.00	IHHTSD0100
125 A				IHKDTF4125	9470.00	IHKDTW4125	11090.00	IHHTSD0125
32 A	TPN	Bolted Type	Without Fuse	IHKDTE4032	2315.00	IHKDTE4032	3940.00	IHHTIA0032
63 A				IHKDTE4063	3235.00	IHKDTE4063	4875.00	IHHTSS0063
100 A				IHKDTE4100	6530.00	IHKDTE4100	8070.00	IHHTSD0100
125 A				IHKDTE4125	8595.00	IHKDTE4125	10215.00	IHHTSD0125
32 A	FP	Bolted Type	With 4 Fuses	IHKDFW4032	3630.00	IHKDFW4032	5360.00	IHHTIA0032
63 A				IHKDFW4063	4635.00	IHKDFW4063	6370.00	IHHTSS0063
100 A				IHKDFW4100	9285.00	IHKDFW4100	11030.00	IHHTSD0100
125 A				IHKDFW4125	11300.00	IHKDFW4125	13135.00	IHHTSD0125
32 A	FP	Bolted Type	Without Fuse	IHKDFE4032	3175.00	IHKDFE4032	4910.00	IHHTIA0032
63 A				IHKDFE4063	4070.00	IHKDFE4063	5810.00	IHHTSS0063
100 A				IHKDFE4100	8115.00	IHKDFE4100	9865.00	IHHTSD0100
125 A				IHKDFE4125	10135.00	IHKDFE4125	11965.00	IHHTSD0125
32 A	TPN	DIN Type	With 3 Fuses	IHKFTW4032	3860.00	IHKFTW4032	5160.00	IHHCD00032
63 A				IHKFTW4063	4910.00	IHKFTW4063	6350.00	IHHCD00063
100 A				IHKFTW4100	8395.00	IHKFTW4100	10015.00	IHHCD00100
125 A				IHKFTW4125	10730.00	IHKFTW4125	12375.00	IHHCD00125
32 A	TPN	DIN Type	Without Fuse	IHKFTE4032	2550.00	IHKFTE4032	3850.00	IHHCD00032
63 A				IHKFTE4063	3550.00	IHKFTE4063	4990.00	IHHCD00063
100 A				IHKFTE4100	6905.00	IHKFTE4100	8525.00	IHHCD00100
125 A				IHKFTE4125	9205.00	IHKFTE4125	10855.00	IHHCD00125
32 A	FP	DIN Type	With 4 Fuses	IHKFFW4032	5250.00	IHKFFW4032	6640.00	IHHCD00032
63 A				IHKFFW4063	6340.00	IHKFFW4063	7860.00	IHHCD00063
100 A				IHKFFW4100	10860.00	IHKFFW4100	12575.00	IHHCD00100
125 A				IHKFFW4125	12010.00	IHKFFW4125	13710.00	IHHCD00125
32 A	FP	DIN Type	Without Fuse	IHKFFE4032	3500.00	IHKFFE4032	4890.00	IHHCD00032
63 A				IHKFFE4063	4525.00	IHKFFE4063	6050.00	IHHCD00063
100 A				IHKFFE4100	8870.00	IHKFFE4100	10590.00	IHHCD00100
125 A				IHKFFE4125	9980.00	IHKFFE4125	11680.00	IHHCD00125

Kompact *plus* Switch Disconnecter Fuse Unit

HSN Code: 8537

(Conforms to IS/IEC:60947- Part 1 & 3)

Switch Disconnecter Fuse (Panel Mounting Cubicle Type) - AC-23 A, 50 Hz, 415 V
Kompact EZO



TPN

Rating A	Pole	Type of Fuse		Item Code	Per Unit LP (₹)	Item Code	Per Unit LP (₹)	Suitable Fuse		
				Open Execution		In Sheet Steel Encl.				
160 A	TPN	Bolted Type	With 3 Fuses	IHFSTF4160	10770.00	IHFSTW4160	13900.00	IHHTSF0160		
200 A				IHFSTF4200	13875.00	IHFSTW4200	16905.00	IHHTSF0200		
250 A				IHFSTF4250	16335.00	IHFSTW4250	19260.00	IHHTSF0250		
320 A				IHFSTF4320	20310.00	IHFSTW4320	23800.00	IHHTSK0315		
400 A				IHFSTF4400	25645.00	IHFSTW4400	28950.00	IHHTSMF400		
630 A				IHFSTF4630	42855.00	IHFSTW4630	46220.00	IHHTLM0630		
800 A				IHFSTF4800	50145.00	IHFSTW4800	53440.00	IHHTLM0800		
160 A				Bolted Type	Without Fuse	IHFSTO4160	9405.00	IHFSTE4160	12540.00	IHHTSF0160
200 A		IHFSTO4200	12510.00			IHFSTE4200	15545.00	IHHTSF0200		
250 A		IHFSTO4250	14860.00			IHFSTE4250	17790.00	IHHTSF0250		
320 A		IHFSTO4320	18380.00			IHFSTE4320	21870.00	IHHTSK0315		
400 A		IHFSTO4400	22015.00			IHFSTE4400	25320.00	IHHTSMF400		
630 A		IHFSTO4630	35485.00			IHFSTE4630	38850.00	IHHTLM0630		
800 A		IHFSTO4800	41930.00			IHFSTE4800	45225.00	IHHTLM0800		
160 A		DIN Type	With 3 Fuses			IHFKTF4160	12020.00	IHFKTW4160	14930.00	IHHCD01160
200 A				IHFKTF4200	14675.00	IHFKTW4200	18250.00	IHHCD01200		
250 A				IHFKTF4250	17205.00	IHFKTW4250	20585.00	IHHCD01250		
320 A				IHFKTF4320	21330.00	IHFKTW4320	24595.00	IHHCD02315		
400 A				IHFKTF4400	25375.00	IHFKTW4400	28620.00	IHHCD02400		
630 A				IHFKTF4630	40740.00	IHFKTW4630	44225.00	IHHCD03630		
160 A				DIN Type	Without Fuse	IHFKTO4160	9815.00	IHFKTE4160	12730.00	IHHCD01160
200 A						IHFKTO4200	12475.00	IHFKTE4200	16050.00	IHHCD01200
250 A		IHFKTO4250	14725.00			IHFKTE4250	18105.00	IHHCD01250		
320 A		IHFKTO4320	18140.00			IHFKTE4320	21405.00	IHHCD02315		
400 A		IHFKTO4400	21940.00			IHFKTE4400	25185.00	IHHCD02400		
630 A		IHFKTO4630	35325.00			IHFKTE4630	38815.00	IHHCD03630		
800 A		IHFKTO4800	38320.00			IHFKTE4800	42700.00			

Kompact *plus* Switch Disconnecter Fuse

(Conforms to IS/IEC:60947- Part 1 & 3)

HSN Code: 8537



Four Pole

Rating A	Pole	Type of Fuse		Item Code	Per Unit LP (₹)	Item Code	Per Unit LP (₹)	Suitable Fuse		
				Open Execution		In Sheet Steel Encl.				
160 A	FP	Bolted Type	With 4 Fuses	IHFSFF4160	14765.00	IHFSFW4160	17780.00	IHHTSF0160		
200 A				IHFSFF4200	17185.00	IHFSFW4200	20010.00	IHHTSF0200		
250 A				IHFSFF4250	19695.00	IHFSFW4250	22410.00	IHHTSF0250		
320 A				IHFSFF4320	22975.00	IHFSFW4320	26095.00	IHHTSK0315		
400 A				IHFSFF4400	28210.00	IHFSFW4400	31845.00	IHHTSMF400		
630 A				IHFSFF4630	47140.00	IHFSFW4630	50840.00	IHHTLM0630		
800 A				IHFSFF4800	55160.00	IHFSFW4800	58780.00	IHHTLM0800		
160 A				Bolted Type	Without Fuse	IHFSFO4160	12950.00	IHFSFE4160	15970.00	IHHTSF0160
200 A		IHFSFO4200	15370.00			IHFSFE4200	18200.00	IHHTSF0200		
250 A		IHFSFO4250	17730.00			IHFSFE4250	20445.00	IHHTSF0250		
320 A		IHFSFO4320	20405.00			IHFSFE4320	24055.00	IHHTSK0315		
400 A		IHFSFO4400	24220.00			IHFSFE4400	27855.00	IHHTSMF400		
630 A		IHFSFO4630	39030.00			IHFSFE4630	42730.00	IHHTLM0630		
800 A		IHFSFO4800	46120.00			IHFSFE4800	49745.00	IHHTLM0800		
160 A		DIN Type	With 4 Fuses			IHFKFF4160	14175.00	IHFKFW4160	16890.00	IHHCD01160
200 A				IHFKFF4200	17850.00	IHFKFW4200	20575.00	IHHCD01200		
250 A				IHFKFF4250	18925.00	IHFKFW4250	22640.00	IHHCD01250		
320 A				IHFKFF4320	23465.00	IHFKFW4320	27060.00	IHHCD02315		
400 A				IHFKFF4400	27915.00	IHFKFW4400	31480.00	IHHCD02400		
630 A				IHFKFF4630	47410.00	IHFKFW4630	50555.00	IHHCD03630		
160 A				DIN Type	Without Fuse	IHFKFO4160	11235.00	IHFKFE4160	13955.00	IHHCD01160
200 A						IHFKFO4200	14915.00	IHFKFE4200	17635.00	IHHCD01200
250 A		IHFKFO4250	16195.00			IHFKFE4250	19915.00	IHHCD01250		
320 A		IHFKFO4320	19955.00			IHFKFE4320	23550.00	IHHCD02315		
400 A		IHFKFO4400	24135.00			IHFKFE4400	27700.00	IHHCD02400		
630 A		IHFKFO4630	40200.00			IHFKFE4630	43340.00	IHHCD03630		
800 A		IHFKFO4800	46530.00			IHFKFE4800	50870.00			

Busbar Chambers - Optima Series

HSN Code: 8536

Busbar Chambers (Wall Mounted)

Busbar made of ETP Grade Copper

Current Rating (A)	No. of	Item Code	Per Unit LP (₹)
63 A	4 WAY	IHBC006304	9675.00
	6 WAY	IHBC006306	11285.00
	8 WAY	IHBC006308	12995.00
100 A	4 WAY	IHBC010004	11610.00
	6 WAY	IHBC010006	16080.00
	8 WAY	IHBC010008	16895.00
200 A	4 WAY	IHBC020004	14525.00
	6 WAY	IHBC020006	18805.00
	8 WAY	IHBC020008	20520.00
250 A	4 WAY	IHBC025004	24045.00
	6 WAY	IHBC025006	37840.00
	8 WAY	IHBC025008	47325.00
315 A	4 WAY	IHBC031504	25120.00
	6 WAY	IHBC031506	38935.00
	8 WAY	IHBC031508	49750.00
400 A	4 WAY	IHBC040004	27140.00
	6 WAY	IHBC040006	40945.00
	8 WAY	IHBC040008	51490.00
630 A	4 WAY	IHBC063004	41570.00
	6 WAY	IHBC063006	55145.00
	8 WAY	IHBC063008	66335.00
800 A	4 WAY	IHBC080004	44220.00
	6 WAY	IHBC080006	58930.00
	8 WAY	IHBC080008	74605.00



HiBreak HBC Fuse Link

(Conforms to IS: 13703-1 & 2-1 / IEC:60269-1 & 2-1)

RH Type HRC Fuse- 80 kA, 415 V

Rating (A)	Item Code	Per Unit LP (₹)	STD Packing No. of unit/s
2 A	IHHRH00002	130.00	20 N
6 A	IHHRH00006	130.00	
10 A	IHHRH00010	130.00	
16 A	IHHRH00016	130.00	20 N
20 A	IHHRH00020	130.00	
25 A	IHHRH00025	130.00	
32 A	IHHRH00032	130.00	20 N
40 A	IHHRH00040	140.00	
50 A	IHHRH00050	295.00	20 N
63 A	IHHRH00063	350.00	20 N



DIN Fuse Bases (Fixed Type)

Specification: IEC: 60269-1 & 2-1 / IS: 13703-1 & 2-1.

Rated A	Item Code	Type	Fuse Type	Per Unit LP (₹)	STD Packing No. of unit/s
160 A	IHUC00O160	Open Type Fuse Base	CD-00	480.00	6 N



i Base - DIN Fuse Bases (Fixed Type)

Specification: IEC: 60269-1 & 2-1 / IS: 13703-1 & 2-1.

Rated A	Item Code	Type	Fuse Type	Per Unit LP (₹)	STD Packing No. of unit/s
250 A	IHIC01O250	Open Type Fuse Base	CD-1	960.00	3 N
400 A	IHIC02O400	Open Type Fuse Base	CD-2	1540.00	3 N
630 A	IHIC03O630	Open Type Fuse Base	CD-3	1795.00	3 N



HiBreak HBC Fuse Link

(Conforms to IS: 13703-1 & 2-1 / IEC:60269-1 & 2-1)

HSN Code: 8536



Bolted Type HRC Fuse - 80 kA, 415 V



DIN Type HRC Fuse - 80 kA, 415 V

IS Size	Tag Type	BS Type	Rating (A)	Item Code	Per Unit LP (₹)	STD Packing No. of unit/s
F-1	Offset	NS	2 A	IHHNS00002	75.00	20 N
			4 A	IHHNS00004	75.00	
			6 A	IHHNS00006	75.00	
			10 A	IHHNS00010	75.00	
			16 A	IHHNS00016	75.00	
			20 A	IHHNS00020	90.00	
			25 A	IHHNS00025	90.00	
			32 A	IHHNS00032	90.00	
A-2	Offset	TIA	16 A	IHHTIA0016	115.00	10 N
			20 A	IHHTIA0020	115.00	
			25 A	IHHTIA0025	115.00	
			32 A	IHHTIA0032	115.00	
A-3	Offset	TSS	40 A	IHHTSS0040	140.00	10 N
			50 A	IHHTSS0050	140.00	
			63 A	IHHTSS0063	140.00	
A-4	Offset	TSD	80 A	IHHTSD0080	290.00	10 N
			100 A	IHHTSD0100	290.00	
			125 A	IHHTSD0125	290.00	
B-1	Central	TSDC	80 A	IHHTSDC080	295.00	10 N
			100 A	IHHTSDC100	295.00	
			125 A	IHHTSDC125	295.00	
B-2	Central	TSF	160 A	IHHTSF0160	455.00	10 N
			200 A	IHHTSF0200	455.00	
			250 A	IHHTSF0250	490.00	
B-3	Central	TSK	315 A	IHHTSK0315	645.00	3 N
B-4	Central	TSMF	400 A	IHHTSMF400	1210.00	3 N
C-1	Central	TSMS	400 A	IHHTSMS400	1210.00	3 N
C-2	Central	TTS	400 A	IHHTTS0400	1380.00	1 N
C-2	Central	TLM	630 A	IHHTLM0630	2455.00	1 N
C-2	Central	TLM	800 A	IHHTLM0800	2740.00	1 N

IS Size	Rating (A)	Item Code	Per Unit LP (₹)	STD Packing No. of unit/s
000	32 A	IHHCD11032	385.00	3 N
	63 A	IHHCD11063	395.00	
	100 A	IHHCD11100	425.00	
00	6 A	IHHCD00006	435.00	3 N
	10 A	IHHCD00010	435.00	
	16 A	IHHCD00016	435.00	
	25 A	IHHCD00025	435.00	
	32 A	IHHCD00032	435.00	
	40 A	IHHCD00040	455.00	
	50 A	IHHCD00050	455.00	
	63 A	IHHCD00063	455.00	
	80 A	IHHCD00080	495.00	
	100 A	IHHCD00100	495.00	
01	125 A	IHHCD00125	510.00	3 N
	160 A	IHHCD00160	535.00	
	40 A	IHHCD01040	725.00	
	50 A	IHHCD01050	725.00	
	100 A	IHHCD01100	725.00	
	125 A	IHHCD01125	725.00	
	160 A	IHHCD01160	735.00	
02	200 A	IHHCD01200	735.00	3 N
	250 A	IHHCD01250	825.00	
	250 A	IHHCD02250	1065.00	
	315 A	IHHCD02315	1065.00	
	350 A	IHHCD02350	1145.00	
03	400 A	IHHCD02400	1145.00	1 N
	500 A	IHHCD03500	1765.00	
	630 A	IHHCD03630	1805.00	

Comprehensive Power Quality Products



Harmonic Duty (MPP)
POWER CAPACITOR & MFD



IOT Based / GSM
IPFC RELAY



**LOAD FLOW &
HARMONICS ANALYSIS**



AHF System
**ACTIVE HARMONIC
FILTER / SVG**



Contactor+
Thyristor Switching
APFC PANEL



High PIV
Thyristor Switch



High Linearity
HD DETUNED REACTOR

**For more details on load flow analysis
Please contact nearest Havells branch**



HAVELLS

Install Havells APFC Panel
&
SAVE Money by reducing kVAh

Why pay more
due to low Power Factor

Is there still a difference in kVAh and KWH in your Electricity Bill due to Low Power Factor?

Billed Units	
334240 kVAh	1
318980 kWh	1
1404 kVA	1



SecuRite APFCS - Automatic Power Factor Correction Panel



Welcome to the world of digitalization and Industry 4.0. Industry 4.0, comprises of Data exchange, Automation, Internet of the things and Cloud computing which prepares manufacturing technologies more efficient and smart. Havells (HGS) Contactors and starters are manufactured through Industry 4.0.

Range

- Output Rating: 10 kVAr -1000 kVAr other rating on request
- Switching: Contactor / Thyristorised (Ultra Fast)

Features

- Manufactured with highly precise modern Amada CNC machine
- 11 tank process for corrosion proof powder coating
- Ergonomic, compact and robust design
- Designed with Fully copper conductor
- Super Heavy Duty Capacitor power capacitor for long life
- Advance G-MOS technology based micro processor relay for intelligent power factor control
- Air core reactor for extra safety from inrush current (High currents)
- Provision of top and bottom cable entry

- Automatic temp. control through fans and louvers in panel
- Double side earthing connection
- Ref. Standard: IEC 61921/ IS 16636 / IEC 61439

Principle Operation

- To continuously sense and monitor the load conditions by the use of the external CT (whose output is fed to the control relay).
- To automatically switch ON and switch OFF relevant capacitor steps to ensure consistent power factor.
- To ensure easy user interface for enabling reliable understanding of system operation, such as display of real time power factor, number of switching operations carried out etc.
- To protect against any electrical faults in a manner that will ensure safe isolation of the power factor correction equipment.

SecuRite APFCS - Automatic Power Factor Correction Panel

IEC: 61921 / IS: 16636

HSN Code: 8537

Rating kVAr	Cat. Code	Description	Per Unit LP (₹)
Rated Voltage 415 Vac, 3 ϕ , 50 Hz, Delta Connection, Cylindrical Capacitor			
10 kVAr	QHKTCB5010X0	10 kVAr / 415 V SecuRite APFC Panel CYCAP	59945.00
12 kVAr	QHKTCB5012X0	12 kVAr / 415 V SecuRite APFC Panel CYCAP	66605.00
15 kVAr	QHKTCB5015X0	15 kVAr / 415 V SecuRite APFC Panel CYCAP	83252.00
25 kVAr	QHKTCB5025X0	25 kVAr / 415 V SecuRite APFC Panel CYCAP	138751.00
30 kVAr	QHKTCB5030X0	30 kVAr / 415 V SecuRite APFC Panel CYCAP	143857.00
50 kVAr	QHKTCB5050X0	50 kVAr / 415 V SecuRite APFC Panel CYCAP	174073.00
75 kVAr	QHKTCB5075X0	75 kVAr / 415 V SecuRite APFC Panel CYCAP	261110.00
100 kVAr	QHKTCB5100X0	100 kVAr / 415 V SecuRite APFC Panel CYCAP	314843.00
125 kVAr	QHKTCB5125X0	125 kVAr / 415 V SecuRite APFC Panel CYCAP	378419.00
150 kVAr	QHKTCB5150X0	150 kVAr / 415 V SecuRite APFC Panel CYCAP	454104.00
175 kVAr	QHKTCB5175X0	175 kVAr / 415 V SecuRite APFC Panel CYCAP	529789.00
200 kVAr	QHKTCB5200X0	200 kVAr / 415 V SecuRite APFC Panel CYCAP	592857.00
225 kVAr	QHKTCB5225X0	225 kVAr / 415 V SecuRite APFC Panel CYCAP	666965.00
250 kVAr	QHKTCB5250X0	250 kVAr / 415 V SecuRite APFC Panel CYCAP	741072.00
275 kVAr	QHKTCB5275X0	275 kVAr / 415 V SecuRite APFC Panel CYCAP	815180.00
300 kVAr	QHKTCB5300X0	300 kVAr / 415 V SecuRite APFC Panel CYCAP	870362.00
325 kVAr	QHKTCB5325X0	325 kVAr / 415 V SecuRite APFC Panel CYCAP	942893.00
350 kVAr	QHKTCB5350X0	350 kVAr / 415 V SecuRite APFC Panel CYCAP	1015422.00

APFC Technical Details

Rating kVAr	Stages	Main Incomer	Breaking Capacity	Dimensions HeightXWidthXDepth (mm)
Rated Voltage 415 Vac, 3 ϕ , 50 Hz, Delta Connection, Super Heavy Duty Cylindrical Capacitor				
10 kVAr	1,1,2,2,4	MCB 25A	10 KA	650x600x200
15 kVAr	1,2,2,2,4,4	MCB 32A	10 KA	650x600x200
20 kVAr	2,2,3,3,5,5	MCB 40A	10 KA	650x600x200
25 kVAr	2,3,5,5,5,5	MCB 63A	10 KA	650x600x200
30 kVAr	2,3,5,5,5,10	MCB 63A	10 kA	900x600x200
50 kVAr	2,3,7.5,12.5,12.5,12.5	MCCB 125A	25 kA	900x600x200
60 kVAr	2,3,5,10,20,20	MCCB 125A	25 kA	900x600x200
75 kVAr	2,3,5,5,10,10,20,20	MCCB 160A	25 KA	1100x700x250
100 kVAr	2,3,5,10,20,20,20,20	MCCB 160A	25 KA	1100x700x250
125 kVAr	2,3,5,5,10,25,25,50	MCCB 250A	35 KA	1175x800x540
150 kVAr	2,3,5,5,10,25,50,50	MCCB 320A	35 KA	1175x800x540
175 kVAr	5,5,5,10,25,25,50,50	MCCB 320A	35 KA	1175x800x540
200 kVAr	5,5,5,10,25,50,50,50	MCCB 400A	35 KA	1175x800x540
225 kVAr	5,7.5,12.5,25,25,50,50,50	MCCB 400A	35 KA	1175x800x540
250 kVAr	5,7.5,12.5,25,50,50,50,50	MCCB 400A	35 KA	1175x800x540
300 kVAr	5,7.5,12.5,25,50,50,50,100	MCCB 500A	50 KA	1675x1200x700
350 kVAr	5,7.5,12.5,25,50,50,100,100	MCCB 630A	50 kA	1675x1200x700
400 kVAr	5,7.5,12.5,25,50,50,50,100,100	MCCB 630 A	50 kA	1675x1200x700
500 kVAr	5,7.5,12.5,25,50,50,100,100,100	MCCB 800 A	50 kA	1675x1200x700

Other Ratings on request

Thyristor Switching Panel (NEW)

Rating kVAr	Cat. Code	Description	Per Unit LP (₹)
10 kVAr - 1000 kVAr	-	10 kVAr -1000 kVAr Thyristor Switching Panel	Price on Request

Current Power Factor cos φ	Achievable (Target)										Target cos φ = 0.96 ^Q
	0.9	0.91	0.92	0.93	0.94	0.95	0.96	0.97	0.98	0.99	
0.51	1.20	1.23	1.26	1.29	1.32	1.36	1.40	1.44	1.48	1.54	1.69
0.52	1.16	1.19	1.22	1.25	1.28	1.31	1.35	1.39	1.44	1.50	1.64
0.53	1.11	1.14	1.17	1.20	1.24	1.27	1.30	1.35	1.40	1.46	1.60
0.54	1.08	1.10	1.13	1.16	1.20	1.23	1.27	1.31	1.36	1.42	1.56
0.55	1.04	1.06	1.09	1.12	1.16	1.19	1.23	1.27	1.32	1.38	1.52
0.56	1.00	1.02	1.05	1.09	1.12	1.15	1.19	1.23	1.28	1.34	1.48
0.57	0.96	0.99	1.02	1.05	1.08	1.11	1.15	1.19	1.24	1.30	1.44
0.58	0.92	0.95	0.98	1.01	1.04	1.08	1.11	1.15	1.20	1.26	1.41
0.59	0.89	0.91	0.94	0.97	1.01	1.04	1.08	1.12	1.17	1.23	1.37
0.60	0.85	0.88	0.91	0.94	0.97	1.00	1.04	1.08	1.13	1.19	1.33
0.61	0.82	0.84	0.87	0.90	0.94	0.97	1.01	1.05	1.10	1.16	1.30
0.62	0.78	0.81	0.84	0.87	0.90	0.94	0.97	1.02	1.06	1.12	1.27
0.63	0.75	0.78	0.81	0.84	0.87	0.90	0.94	0.98	1.03	1.09	1.23
0.64	0.72	0.75	0.78	0.81	0.84	0.87	0.91	0.95	1.00	1.07	1.20
0.65	0.69	0.71	0.74	0.77	0.81	0.84	0.88	0.92	0.97	1.03	1.17
0.66	0.65	0.68	0.71	0.74	0.78	0.81	0.85	0.89	0.94	1.00	1.14
0.67	0.62	0.65	0.68	0.71	0.75	0.78	0.82	0.86	0.91	0.97	1.11
0.68	0.59	0.62	0.65	0.68	0.72	0.75	0.79	0.83	0.88	0.94	1.08
0.69	0.57	0.59	0.62	0.65	0.69	0.72	0.76	0.80	0.85	0.91	1.05
0.70	0.54	0.56	0.59	0.63	0.66	0.69	0.73	0.77	0.82	0.88	1.02
0.71	0.51	0.54	0.57	0.60	0.63	0.66	0.70	0.74	0.79	0.85	0.99
0.72	0.48	0.51	0.54	0.57	0.60	0.64	0.67	0.71	0.76	0.82	0.96
0.73	0.45	0.48	0.51	0.54	0.57	0.61	0.64	0.69	0.73	0.79	0.94
0.74	0.43	0.45	0.48	0.51	0.55	0.58	0.62	0.66	0.71	0.77	0.91
0.75	0.40	0.43	0.46	0.49	0.52	0.55	0.59	0.63	0.68	0.74	0.88
0.76	0.37	0.40	0.43	0.46	0.49	0.53	0.56	0.60	0.65	0.71	0.86
0.77	0.35	0.37	0.40	0.43	0.47	0.50	0.44	0.58	0.63	0.69	0.83
0.78	0.32	0.35	0.38	0.41	0.44	0.47	0.51	0.55	0.60	0.66	0.80
0.79	0.29	0.32	0.35	0.38	0.41	0.45	0.48	0.53	0.57	0.63	0.78
0.80	0.27	0.29	0.32	0.36	0.39	0.42	0.46	0.50	0.55	0.61	0.75
0.81	0.24	0.27	0.30	0.33	0.36	0.40	0.43	0.47	0.52	0.58	0.72
0.82	0.21	0.24	0.27	0.30	0.34	0.37	0.41	0.45	0.50	0.56	0.70
0.83	0.19	0.22	0.25	0.28	0.31	0.34	0.38	0.42	0.47	0.53	0.67
0.84	0.16	0.19	0.22	0.25	0.28	0.32	0.35	0.40	0.44	0.50	0.65
0.85	0.14	0.16	0.19	0.23	0.26	0.29	0.33	0.37	0.42	0.48	0.62
0.86	0.11	0.14	0.17	0.20	0.23	0.26	0.30	0.34	0.39	0.45	0.59
0.87	0.08	0.11	0.14	0.17	0.20	0.24	0.28	0.32	0.36	0.43	0.57
0.88	0.06	0.08	0.11	0.15	0.18	0.21	0.25	0.29	0.34	0.40	0.54
0.89	0.03	0.06	0.09	0.12	0.15	0.18	0.22	0.26	0.31	0.37	0.51
0.90	0.00	0.03	0.06	0.09	0.12	0.16	0.19	0.23	0.28	0.34	0.48
0.91		0.00	0.03	0.06	0.09	0.13	0.16	0.21	0.25	0.31	0.46
0.92			0.00	0.03	0.06	0.10	0.13	0.18	0.22	0.28	0.43
0.93				0.00	0.03	0.07	0.10	0.14	0.19	0.25	0.40
0.94					0.00	0.03	0.07	0.11	0.16	0.22	0.36
0.95						0.00	0.04	0.08	0.13	0.19	0.33

Example:

Actual Motor Power P=100 kW

Actual cos φ 0.61

Factor F from table 1.01

Target cos φ (Q) 0.96

Capacitor reactive power Qc = 100 x 1.01 = 101 kVAR

Selection of Capacitor

(I) Calculation of Required kVAR.

Operating load kW and its average power factor (PF) as per the electricity bill OR we can easily calculate by a simple formula

Average PF = kW / kVA

Operating load kW = kVA Demand x Average PF

Average PF is considered as the initial PF and the final PF is assumed as a target PF. From this information required kVAR can be easily calculated with reference table.

Example: Calculate required kVAR to improve PF from 0.75 to 0.96 for 500 kW installation

kVAR = kW x multiplying factor from table = 500 x 0.590 = 295 kVAR

(II) Selection of Capacitor Duty

Selection of Capacitor Type is first decision to be made

Power Factor Correction Capacitor can be classified as follows.

Splendid Duty - Torrent and Master

Heavy Duty - Champ

SHD / UHDXL - Warrior and Champion (Double Di-electric)

Refer following table for the capacitor duty based on type of Industry / Application

Power Capacitor Selection Chart on the basis of Application				
% Non linear load	≤ 10%	Up to 15%	Up to 20%	Between 20% to 30%
Square	Master Splendid Duty	Champ HD Plus	Champion UHDXL	Champ HD Plus + Reactor
Cylindrical	Torrent Splendid Duty	Warrior SHD	Warrior SHD	Warrior SHD + Reactor
Application	These Capacitors are designed for normal loads where non linear factor is <10%. Do not use normal duty capacitors for the application of Heavy Duty and Super Heavy Duty capacitors.	Commercial building with CFL lamps, SMPS, UPS etc.	Heavy Chemical Industries	Steel plant
		Garment industries (Sewing Industry)	Pharmaceutical Industries	Cement Industries
		Bakeries	Automobile plants	Stone crushing
		Flour mills	Paper Industries	Textiles (Production of Yarn/cloth)
		Oil mills	Food processing plants	Forging Industries
		Glass industries	IT Industries	Power frequency induction furnaces
		Rice mills	Fabrication shops	Sugar plants
		Cold storage	Welding shops	Rolling mills
			Machine and tool shop	
Example for Calculating Non Linear Load Installed Transformer Rating = 1000 kVA Non Linear Loads = 100 kVA % Non Linear Load = (Non Linear Load / Transformer Rating) X 100 = (100/1000) X 100 = 10%				
Example of Non Linear Loads: UPS, Arc / Induction furnace, Rectifiers, AC / DC Drives, Computer, CFL, CNC Machines.				

Consulting, Optimizing & Delivering Performance



Magnetic Contactor

Capacitor Duty Contactor

Features:

- Range : 3 kVAr to 66 kVAr
- **De-latching Type design of Resistor Switching Block**
- Low VA Burden Wide operating band coils with Class H Insulation
- Common accessories with HGS Range
- **High Operating Frequency - 240 Operations/Hour**
- Handle high inrush current capability
- Utilization category AC-6b
- Finger proof IP20 terminals

Frame Size	kVAr Rating AC-6b	Inst. Aux. Contact		Item Code	Per Unit LP (₹)
	415 V / 440 V	NO	NC		
1	3 kVAr	1	0	IHPHE003110*	2155.00
	3 kVAr	0	1	IHPHE003101*	2155.00
	5 kVAr	1	0	IHPHE005110*	2261.00
	5 kVAr	0	1	IHPHE005101*	2261.00
	10 kVAr	1	0	IHPHE010110*	2738.00
	10 kVAr	0	1	IHPHE010101*	2738.00
	12.5 kVAr	1	0	IHPHE12X110*	3093.00
	12.5 kVAr	0	1	IHPHE12X101*	3093.00
	15 kVAr	1	0	IHPHE015110*	3787.00
	15 kVAr	0	1	IHPHE015101*	3787.00
2	20 kVAr	1	0	IHPHE020210*	4163.00
	20 kVAr	0	1	IHPHE020201*	4163.00
	25 kVAr	1	0	IHPHE025210*	4748.00
	25 kVAr	0	1	IHPHE025201*	4748.00
3	33.3 kVAr	1	0	IHPHE33X210*	6882.00
	33.3 kVAr	0	1	IHPHE33X201*	6882.00
3	33.3 kVAr	1	1	IHPHE33X311*	8300.00
	40 kVAr	2	2	IHPHE040322*	12757.00
4	50 kVAr	2	2	IHPHE050422*	13272.00
	66 kVAr	2	2	IHPHE066422*	15575.00

*To complete the Cat no. suffix the coil voltage from the coil voltage table

NEW 33.3 kVAr contactor in Frame-3 can be used where higher terminal capacity is required.

Other Ratings on request

Intelligent Power Factor Controller

IEC: 61010-1

IPFC (Single CT Sensing)

HSN Code: 9032

Range:

08 and 12 Steps
7 segment LED display
Size: 144 mm x 144 mm

Features:

- Auxiliary supply 90 Vac - 550 Vac
- Intelligent Power Factor Algorithm
- Dual Password Protection
- 4 digit display (0.XXX) PF
- Alarm Indication on Display
- Switching time programmable 1 s to 180 s

Range:

08 Steps
LCD display
Size: 96 mm x 96 mm

Features:

- Auxiliary supply 230 Vac
- Advance 32 bit Micro Controller Base Processing
- Intelligent Power Factor Algorithm
- Alarm Indication on Display
- Switching time programmable 1 s to 600 s

IPFC (Three CT Sensing)

Range:

08, 12 and 14 Steps
LCD display
Relay output
Size: 144 mm x 144 mm

Features:

- LCD Type with dual colour backlight
- Auxiliary supply 90 Vac - 550 Vac
- Dual Password Protection
- Automatic CT Polarity detection
- NTC Temperature Sensor
- Communication Interface RS 485 & ModBus RTU (Only for 12 Relay option)
- Power Factor Measurement Range: 0.8 lag to 0.8 lead

Range:

08 and 12 Steps
LCD display
Relay / Thyristor output
Size: 144 mm x 144 mm

Features:

- Advance Micro-Controller based logic
- LCD Type with colour backlight
- Auxiliary supply 90 Vac - 550 Vac
- Data logging facility (optional)
- Automatic CT Polarity detection
- Communication Interface RS485 & ModBus RTU
GSM / WiFi
- Power Factor Measurement Range: 0.8 lag to 0.8 lead

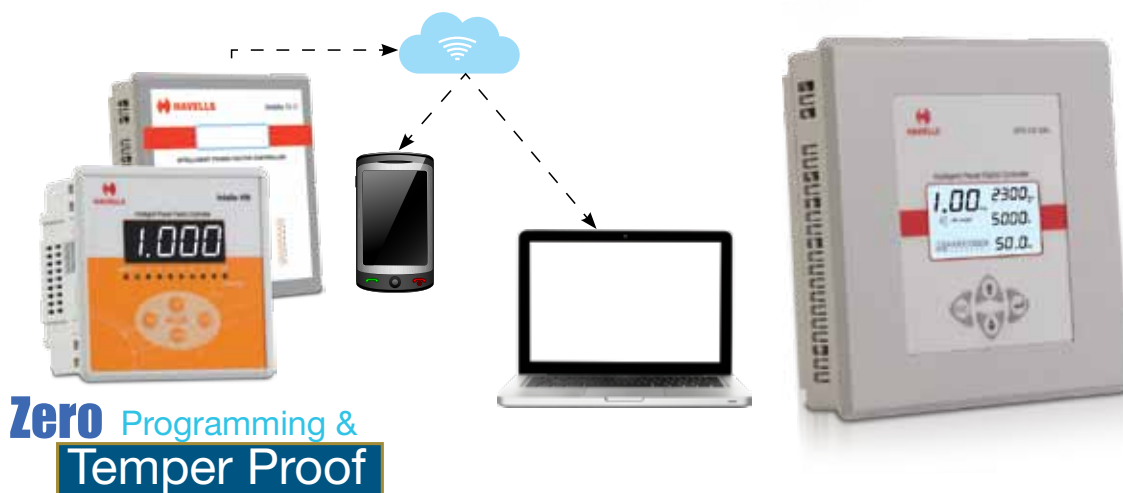

Steps	Item Code	Description	Standard Pack No of unit/s	Master Pack No of unit/s	Per Unit LP (₹)
Intelligent Power Factor Controller (IPFC CS- 1001) 1 CT					
12	QHOSBS5N0012	IPFC CS 1001-112-90 V / 550 Vac 144 x 144	1 N	5 N	13585.00
12	QHOTBS5H0012	IPFC CS 1003-312-90 V / 550 Vac 144 x 144	1 N	5 N	23402.00
8	QHOSBS5*	IPFC CS 96 x 96	1 N	5 N	7084.00

Manufactured by Swiss Technology



Power Capacitors			
Parameters	Splendid Duty	Heavy Duty / HD Plus	UHDXL / Super Heavy Duty
Type	MPP	MPP	MPP
Over Current withstand capacity upto	1.6 X Ir	2.4 X Ir / 2.2 Ir	3.2 X Ir / 3.0 X Ir
Peak Inrush Current Withstand Capacity upto	250 times	350 times / 350 times	500 times / 500 times
Losses	0.2 W / kVAr	0.2 W / kVAr	0.2 W / kVAr
No of switching per year	35000	50000 / 52500	65000 / 80000
Max Ambient Temp (°C)	55 °C	60 °C	65 °C
Operating life in hours	120000	200000 / 215000	250000 / 300000
Notch Shield	Yes	Yes	Yes
Over pressure Disconnecter	Yes	Yes	Yes
Triple Safety	Yes	Yes	Yes



Torrent - Splendid Duty Cylindrical Capacitors

HSN Code: 8532
(IS: 13340 / IEC: 60831)

Rating kVAr	Item Code	Description	Ir A	C μF	Standard Pack No of unit/s	Master Pack No of unit/s	Per Unit LP (₹)
Rated Voltage 440 Vac, 3φ, 50 Hz, Delta Connection							
1 kVAr	QHUTCC5001X0	Torrent 440 V 50 Hz-1 kVAr 3 PH	1.31	3 X 5.5	1 N	16 N	221.00
2 kVAr	QHUTCC5002X0	Torrent 440 V 50 Hz-2 kVAr 3 PH	2.62	3 X 11.0	1 N	16 N	441.00
3 kVAr	QHUTCC5003X0	Torrent 440 V 50 Hz-3 kVAr 3 PH	3.94	3 X 16.4	1 N	16 N	666.00
4 kVAr	QHUTCC5004X0	Torrent 440 V 50 Hz-4 kVAr 3 PH	5.25	3 X 21.9	1 N	16 N	888.00
5 kVAr	QHUTCC5005X0	Torrent 440 V 50 Hz-5 kVAr 3 PH	6.56	3 X 27.4	1 N	16 N	1110.00
6 kVAr	QHUTCC5006X0	Torrent 440 V 50 Hz-6 kVAr 3 PH	7.87	3 X 32.9	1 N	8 N	1332.00
7.5 kVAr	QHUTCC5007X5	Torrent 440 V 50 Hz-7.5 kVAr 3P H	9.84	3 X 41.1	1 N	8 N	1665.00
10 kVAr	QHUTCC5010X0	Torrent 440 V 50 Hz-10 kVAr 3 PH	13.12	3 X 54.8	1 N	8 N	2220.00
12.5 kVAr	QHUTCC5012X5	Torrent 440 V 50 Hz-12.5 kVAr 3 PH	16.40	3 X 68.5	1 N	8 N	2775.00
15 kVAr	QHUTCC5015X0	Torrent 440 V 50 Hz-15 kVAr 3 PH	19.68	3 X 82.2	1 N	4 N	3330.00
20 kVAr	QHUTCC5020X0	Torrent 440 V 50 Hz-20 kVAr 3 PH	26.24	3 X 109.6	1 N	4 N	4439.00
25 kVAr	QHUTCC5025X0	Torrent 440 V 50 Hz-25 kVAr 3 PH	32.80	3 X 137.0	1 N	4 N	5550.00
30 kVAr	QHUTCC5030X0	Torrent 440 V 50 Hz-30 kVAr 3 PH	39.37	3 X 164.4	1 N	4 N	6660.00

Warrior - Super Heavy Duty Cylindrical Capacitors (NEW)

HSN Code: 8532
(IS: 13340 / IEC: 60831)

Rating kVAr	Item Code	Description	Ir A	C μF	Standard Pack No of unit/s	Master Pack No of unit/s	Per Unit LP (₹)
Rated Voltage 440 Vac, 3φ, 50 Hz, Delta Connection							
1 kVAr	QHBTCC5001X0	Warrior Super Heavy Duty 440 V 50 Hz 1 kVAr 3 PH	1.31	3 X 5.5	1 N	16 N	332.00
2 kVAr	QHBTCC5002X0	Warrior Super Heavy Duty 440 V 50 Hz 2 kVAr 3 PH	2.62	3 X 11.0	1 N	16 N	606.00
3 kVAr	QHBTCC5003X0	Warrior Super Heavy Duty 440 V 50 Hz 3 kVAr 3 PH	3.94	3 X 16.4	1 N	16 N	909.00
4 kVAr	QHBTCC5004X0	Warrior Super Heavy Duty 440 V 50 Hz 4 kVAr 3 PH	5.25	3 X 21.9	1 N	16 N	1212.00
5 kVAr	QHBTCC5005X0	Warrior Super Heavy Duty 440 V 50 Hz 5 kVAr 3 PH	6.56	3 X 27.4	1 N	16 N	1515.00
6 kVAr	QHBTCC5006X0	Warrior Super Heavy Duty 440 V 50 Hz 7.5 kVAr 3 PH	7.87	3 X 32.9	1 N	8 N	1818.00
7.5 kVAr	QHBTCC5007X5	Warrior Super Heavy Duty 440 V 50 Hz 6 kVAr 3 PH	9.84	3 X 41.1	1 N	8 N	2272.00
8 kVAr	QHBTCC5008X0	Warrior Super Heavy Duty 440 V 50 Hz 8 kVAr 3 PH	10.50	3 X 43.8	1 N	8 N	2423.00
10 kVAr	QHBTCC5010X0	Warrior Super Heavy Duty 440 V 50 Hz 10 kVAr 3 PH	13.12	3 X 54.8	1 N	4 N	3029.00
12.5 kVAr	QHBTCC5012X5	Warrior Super Heavy Duty 440 V 50 Hz 12.5 kVAr 3 PH	16.40	3 X 68.5	1 N	4 N	3786.00
15 kVAr	QHBTCC5015X0	Warrior Super Heavy Duty 440 V 50 Hz 15 kVAr 3 PH	19.68	3 X 82.2	1 N	4 N	4544.00
20 kVAr	QHBTCC5020X0	Warrior Super Heavy Duty 440 V 50 Hz 20 kVAr 3 PH	26.24	3 X 109.6	1 N	4 N	6059.00
25 kVAr	QHBTCC5025X0	Warrior Super Heavy Duty 440 V 50 Hz 25 kVAr 3 PH	32.80	3 X 137.0	1 N	4 N	7574.00
30 kVAr	QHBTCC5030X0	Warrior Super Heavy Duty 440 V 50 Hz 30 kVAr 3 PH	39.37	3 X 164.4	1 N	4 N	9089.00
Rated Voltage 480 Vac, 3φ, 50 Hz, Delta Connection							
5 kVAr	QHBTCD5005X0	Warrior Super Heavy Duty 480 V 50 Hz 5 kVAr 3 PH	6.01	3 x 23.0	1 N	16 N	1562.00
7.5 kVAr	QHBTCD5007X5	Warrior Super Heavy Duty 480 V 50 Hz 7.5 kVAr 3 PH	9.02	3 x 34.5	1 N	8 N	2345.00
10 kVAr	QHBTCD5010X0	Warrior Super Heavy Duty 480 V 50 Hz 10 kVAr 3 PH	12.03	3 x 46.0	1 N	4 N	3126.00
12.5 kVAr	QHBTCD5012X5	Warrior Super Heavy Duty 480 V 50 Hz 12.5 kVAr 3 PH	15.04	3 x 57.6	1 N	4 N	3907.00
15 kVAr	QHBTCD5015X0	Warrior Super Heavy Duty 480 V 50 Hz 15 kVAr 3 PH	18.04	3 x 69.1	1 N	4 N	4688.00
20 kVAr	QHBTCD5020X0	Warrior Super Heavy Duty 480 V 50 Hz 20 kVAr 3 PH	24.06	3 x 92.1	1 N	4 N	6251.00
25 kVAr	QHBTCD5025X0	Warrior Super Heavy Duty 480 V 50 Hz 25 kVAr 3 PH	30.07	3 x 115.1	1 N	4 N	7814.00
30 kVAr	QHBTCD5030X0	Warrior Super Heavy Duty 480 V 50 Hz 30 kVAr 3 PH	36.09	3 X 138.2	1 N	4 N	9377.00
Rated Voltage 525 Vac, 3φ, 50 Hz, Delta Connection							
5 kVAr	QHBTCF5005X0	Warrior Super Heavy Duty 525 V 50 Hz 5 kVAr 3 PH	5.50	3 X 19.2	1 N	16 N	1562.00
7.5 kVAr	QHBTCF5007X5	Warrior Super Heavy Duty 525 V 50 Hz 7.5 kVAr 3 PH	8.25	3 X 28.9	1 N	8 N	2345.00
10 kVAr	QHBTCF5010X0	Warrior Super Heavy Duty 525 V 50 Hz 10 kVAr 3 PH	13.75	3 X 48.1	1 N	4 N	3126.00
12.5 kVAr	QHBTCF5012X5	Warrior Super Heavy Duty 525 V 50 Hz 12.5 kVAr 3 PH	14.52	3 X 50.8	1 N	4 N	3907.00
15 kVAr	QHBTCF5015X0	Warrior Super Heavy Duty 525 V 50 Hz 15 kVAr 3 PH	18.37	3 X 64.3	1 N	4 N	4688.00
20 kVAr	QHBTCF5020X0	Warrior Super Heavy Duty 525 V 50 Hz 20 kVAr 3 PH	29.14	3 X 102.0	1 N	4 N	6251.00
25 kVAr	QHBTCF5025X0	Warrior Super Heavy Duty 525 V 50 Hz 25 kVAr 3 PH	27.50	3 x 96.25	1 N	4 N	7814.00
30 kVAr	QHBTCF5030X0	Warrior Super Heavy Duty 525 V 50 Hz 30 kVAr 3 PH	32.99	3 X 115.4	1 N	4 N	9378.00

Other Ratings on request

Mini / Master - Splendid Duty Square Capacitors



HSN Code: 8532
(IS: 13340 / IEC: 60831)

Rating kVAr	Item Code	Description	I A	C μ F	Standard Pack No of unit/s	Master Pack No of unit/s	Per Unit LP (₹)
Rated Voltage 440 Vac, 3 ϕ , 50 Hz, Delta Connection							
1 kVAr	QHNTMC5001X0	Mini Master 440 V 50 Hz-1 kVAr 3 PH	1.31	3 x 5.5	1 N	30 N	362.00
2 kVAr	QHNTMC5002X0	Mini Master 440 V 50 Hz-2 kVAr 3 PH	2.62	3 x 11.0	1 N	30 N	582.00
3 kVAr	QHNTMC5003X0	Mini Master 440 V 50 Hz-3 kVAr 3 PH	3.94	3 x 16.4	1 N	24 N	873.00
kVAr 4	QHNTMC5004X0	Mini Master 440 V 50 Hz-4 kVAr 3 PH	5.25	3 x 21.9	1 N	24 N	1162.00
kVAr 5	QHNTMC5005X0	Mini Master 440 V 50 Hz-5 kVAr 3 PH	6.56	3 x 27.4	1 N	24 N	1357.00
6 kVAr	QHNTMC5006X0	Master 440 V 50 Hz-6 kVAr 3 PH	7.87	3 x 32.9	1 N	1 N	1628.00
7.5 kVAr	QHNTMC5007X5	Master 440 V 50 Hz-7.5 kVAr 3 PH	9.84	3 x 41.1	1 N	1 N	2035.00
8 kVAr	QHNTMC5008X0	Master 440 V 50 Hz-8 kVAr 3 PH	10.5	3 x 43.8	1 N	1 N	2170.00
10 kVAr	QHNTMC5010X0	Master 440 V 50 Hz-10 kVAr 3 PH	13.12	3 x 54.8	1 N	1 N	2713.00
12.5 kVAr	QHNTMC5012X5	Master 440 V 50 Hz-12.5 kVAr 3 PH	16.40	3 x 68.5	1 N	1 N	3392.00
15 kVAr	QHNTMC5015X0	Master 440 V 50 Hz-15 kVAr 3 PH	19.68	3 x 82.2	1 N	1 N	4070.00
20 kVAr	QHNTMC5020X0	Master 440 V 50 Hz-20 kVAr 3 PH	26.24	6 x 54.8	1 N	1 N	5426.00
25 kVAr	QHNTMC5025X0	Master 440 V 50 Hz-25 kVAr 3 PH	32.80	6 x 68.5	1 N	1 N	6783.00
30 kVAr	QHNTMC5030X0	Master 440 V 50 Hz-30 kVAr 3 PH	39.37	6 x 82.2	1 N	1 N	8140.00
50 kVAr	QHNTMC5050X0	Master 440 V 50 Hz-50 kVAr 3 PH	65.61	12 x 68.5	1 N	1 N	13566.00

Other Ratings on request



Champ - Heavy Duty Plus Square Capacitors

HSN Code: 8532
(IS: 13340 / IEC: 60831)

Rating kVAr	Item Code	Description	Ir A	C μ F	Standard Pack No of unit/s	Master Pack No of unit/s	Per Unit LP (₹)
Rated Voltage 440 Vac, 3 ϕ , 50 Hz, Delta Connection							
1 kVAr	QHBTMC5001X0	Champ 440 V 50 Hz-1 kVAr 3 PH	1.31	3 x 5.5	1 N	30 N	426.00
2 kVAr	QHBTMC5002X0	Champ 440 V 50 Hz-2 kVAr 3 PH	2.62	3 x 11.0	1 N	30 N	775.00
3 kVAr	QHBTMC5003X0	Champ 440 V 50 Hz-3 kVAr 3 PH	3.94	3 x 16.4	1 N	24 N	1162.00
4 kVAr	QHBTMC5004X0	Champ 440 V 50 Hz-4 kVAr 3 PH	5.25	3 x 21.9	1 N	24 N	1551.00
5 kVAr	QHBTMC5005X0	Champ 440 V 50 Hz-5 kVAr 3 PH	6.56	3 x 27.4	1 N	1 N	1873.00
6 kVAr	QHBTMC5006X0	Champ 440 V 50 Hz-6 kVAr 3 PH	7.87	3 x 32.9	1 N	1 N	2248.00
7.5 kVAr	QHBTMC5007X5	Champ 440 V 50 Hz-7.5 kVAr 3 PH	9.84	3 x 41.1	1 N	1 N	2810.00
8 kVAr	QHBTMC5008X0	Champ 440 V 50 Hz-8 kVAr 3 PH	10.50	3 x 43.8	1 N	1 N	2998.00
10 kVAr	QHBTMC5010X0	Champ 440 V 50 Hz-10 kVAr 3 PH	13.12	3 x 54.8	1 N	1 N	3746.00
12.5 kVAr	QHBTMC5012X5	Champ 440 V 50 Hz-12.5 kVAr 3 PH	16.40	3 x 68.5	1 N	1 N	4684.00
15 kVAr	QHBTMC5015X0	Champ 440 V 50 Hz-15 kVAr 3 PH	19.68	3 x 82.2	1 N	1 N	5621.00
20 kVAr	QHBTMC5020X0	Champ 440 V 50 Hz-20 kVAr 3 PH	26.24	6 x 54.8	1 N	1 N	7494.00
25 kVAr	QHBTMC5025X0	Champ 440 V 50 Hz-25 kVAr 3PH	32.80	6 x 68.5	1 N	1 N	9367.00
30 kVAr	QHBTMC5030X0	Champ 440 V 50 Hz-30 kVAr 3 PH	39.37	6 x 82.2	1 N	1 N	11240.00
50 kVAr	QHBTMC5050X0	Champ 440 V 50 Hz-50 kVAr 3 PH	65.61	12 x 68.5	1 N	1 N	19703.00
75 kVAr	QHBTMC5075X0	Champ 440 V 50 Hz-75 kVAr 3 PH	98.40	18 x 68.5	1 N	1 N	29555.00
100 kVAr	QHBTMC5100X0	Champ 440 V 50 Hz-100 kVAr 3 PH	131.22	24 x 68.5	1 N	1 N	39407.00

Champ - Heavy Duty Plus Square Capacitors

HSN Code: 8532

(IS: 13340 / IEC: 60831)

Rating kVAr	Item Code	Description	Ir A	C μ F	Standard Pack No of unit/s	Master Pack No of unit/s	Per Unit LP (₹)
Rated Voltage 480 Vac, 3ϕ, 50 Hz, Delta Connection							
5 kVAr	QHBTMD5005X0	Champ 480 V 50 Hz-5 kVAr 3 PH	6.01	3 x 23	1 N	1 N	2035.00
6 kVAr	QHBTMD5006X0	Champ 480 V 50 Hz-6 kVAr 3 PH	7.22	3 x 27.6	1 N	1 N	2442.00
7.5 kVAr	QHBTMD5007X5	Champ 480 V 50 Hz-7.5 kVAr 3 PH	9.02	3 x 34.5	1 N	1 N	3052.00
10 kVAr	QHBTMD5010X0	Champ 480 V 50 Hz-10 kVAr 3 PH	12.03	3 x 46.0	1 N	1 N	4070.00
12.5 kVAr	QHBTMD5012X5	Champ 480 V 50 Hz-12.5 kVAr 3 PH	15.04	3 x 57.6	1 N	1 N	5087.00
15 kVAr	QHBTMD5015X0	Champ 480 V 50 Hz-15 kVAr 3 PH	18.04	3 x 69.1	1 N	1 N	6105.00
20 kVAr	QHBTMD5020X0	Champ 480 V 50 Hz-20 kVAr 3 PH	24.06	6 X 46.0	1 N	1 N	8140.00
25 kVAr	QHBTMD5025X0	Champ 480 V 50 Hz-25 kVAr 3 PH	30.07	6 X 57.6	1 N	1 N	10175.00
30 kVAr	QHBTMD5030X0	Champ 480 V 50 Hz-30 kVAr 3 PH	36.09	6 X 69.1	1 N	1 N	12209.00
50 kVAr	QHBTMD5050X0	Champ 480 V 50 Hz-50 kVAr 3 PH	60.14	12 X 57.6	1 N	1 N	20349.00
60 kVAr	QHBTMD5060X0	Champ 480 V 50 Hz-60 kVAr 3 PH	72.18	12 X 69.1	1 N	1 N	24419.00
Rated Voltage 525 Vac, 3ϕ, 50 Hz, Delta Connection							
5 kVAr	QHBTMF5005X0	Champ 525 V 50 Hz-5 kVAr 3 PH	5.50	3 X 19.2	1 N	1 N	2035.00
6 kVAr	QHBTMF5006X0	Champ 525 V 50 Hz-6 kVAr 3 PH	6.60	3 X 23.1	1 N	1 N	2442.00
7.5 kVAr	QHBTMF5007X5	Champ 525 V 50 Hz-7.5 kVAr 3 PH	8.25	3 X 28.9	1 N	1 N	3052.00
10 kVAr	QHBTMF5010X0	Champ 525 V 50 Hz-10 kVAr 3 PH	11.00	3 X 38.5	1 N	1 N	4070.00
12.5 kVAr	QHBTMF5012X5	Champ 525 V 50 Hz-12.5 kVAr 3 PH	13.75	3 X 48.1	1 N	1 N	5087.00
15 kVAr	QHBTMF5015X0	Champ 525 V 50 Hz-15 kVAr 3 PH	16.50	3 X 57.7	1 N	1 N	6105.00
20 kVAr	QHBTMF5020X0	Champ 525 V 50 Hz-20 kVAr 3 PH	21.99	6 X 38.5	1 N	1 N	8140.00
25 kVAr	QHBTMF5025X0	Champ 525 V 50 Hz-25 kVAr 3 PH	27.49	6 X 48.1	1 N	1 N	10175.00
30 kVAr	QHBTMF5030X0	Champ 525 V 50 Hz-30 kVAr 3 PH	32.99	6 X 57.7	1 N	1 N	12209.00
50 kVAr	QHBTMF5050X0	Champ 525 V 50 Hz-50 kVAr 3 PH	54.99	12 X 48.1	1 N	1 N	20996.00
60 kVAr	QHBTMF5060X0	Champ 525 V 50 Hz-60 kVAr 3 PH	65.98	12 X 57.7	1 N	1 N	25195.00

Champion - UHDXL (Double Dielectric) Square Capacitors

Rating kVAr	Item Code	Description	Ir A	C μ F	Standard Pack No of unit/s	Master Pack No of unit/s	Per Unit LP (₹)
Rated Voltage 440 Vac, 3ϕ, 50 Hz, Delta Connection							
1 kVAr	QHSTMC5001X0	Champion 440 V 50 Hz-1 kVAr 3 PH	1.31	3 X 5.5	1 N	24 N	879.00
2 kVAr	QHSTMC5002X0	Champion 440 V 50 Hz-2 kVAr 3 PH	2.62	3 X 11.0	1 N	1 N	1757.00
3 kVAr	QHSTMC5003X0	Champion 440 V 50 Hz-3 kVAr 3 PH	3.94	3 X 16.4	1 N	1 N	2636.00
4 kVAr	QHSTMC5004X0	Champion 440 V 50 Hz-4 kVAr 3 PH	5.25	3 X 21.9	1 N	1 N	3056.00
5 kVAr	QHSTMC5005X0	Champion 440 V 50 Hz-5 kVAr 3 PH	6.56	3 X 27.4	1 N	1 N	3084.00
6 kVAr	QHSTMC5006X0	Champion 440 V 50 Hz-6 kVAr 3 PH	7.87	3 X 32.9	1 N	1 N	3488.00
7.5 kVAr	QHSTMC5007X5	Champion 440 V 50 Hz-7.5 kVAr 3 PH	9.84	3 X 41.1	1 N	1 N	4361.00
8 kVAr	QHSTMC5008X0	Champion 440 V 50 Hz-8 kVAr 3 PH	10.5	3 X 43.8	1 N	1 N	4652.00
10 kVAr	QHSTMC5010X0	Champion 440 V 50 Hz-10 kVAr 3 PH	13.12	3 X 54.8	1 N	1 N	5814.00
12.5 kVAr	QHSTMC5012X5	Champion 440 V 50 Hz-12.5 kVAr 3 PH	16.40	3 X 68.5	1 N	1 N	7268.00
15 kVAr	QHSTMC5015X0	Champion 440 V 50 Hz-15 kVAr 3 PH	19.68	6 X 41.1	1 N	1 N	8721.00
20 kVAr	QHSTMC5020X0	Champion 440 V 50 Hz-20 kVAr 3 PH	26.24	6 X 54.8	1 N	1 N	11629.00
25 kVAr	QHSTMC5025X0	Champion 440 V 50 Hz-25 kVAr 3 PH	32.80	6 X 68.5	1 N	1 N	14535.00
30 kVAr	QHSTMC5030X0	Champion 440 V 50 Hz-30 kVAr 3 PH	39.37	12 X 41.1	1 N	1 N	18218.00
50 kVAr	QHSTMC5050X0	Champion 440 V 50 Hz-50 kVAr 3 PH	65.61	12 X 68.5	1 N	1 N	30363.00
75 kVAr	QHSTMC5075X0	Champion 440 V 50 Hz-75 kVAr 3 PH	98.41	18 X 68.5	1 N	1 N	45544.00
100 kVAr	QHSTMC5100X0	Champion 440 V 50 Hz-100 kVAr 3 PH	131.22	24 X 68.5	1 N	1 N	60726.00

Other Ratings on request

Champion - UHDXL (Double Dielectric) Square Capacitors

HSN Code: 8532

(IS: 13340 / IEC: 60831)

Rating kVAr	Item Code	Description	I _r A	C μF	Standard Pack No of unit/s	Master Pack No of unit/s	Per Unit LP (₹)
Rated Voltage 480 Vac, 3ø, 50 Hz, Delta Connection							
5 kVAr	QHSTMD5005X0	Champion 480 V 50 Hz-5 kVAr 3 PH	6.01	3 X 23.0	1 N	1 N	2907.00
6 kVAr	QHSTMD5006X0	Champion 480 V 50 Hz-6 kVAr 3 PH	7.22	3 X 27.6	1 N	1 N	3488.00
7.5 kVAr	QHSTMD5007X5	Champion 480 V 50 Hz-7.5 kVAr 3 PH	9.02	3 X 34.5	1 N	1 N	4361.00
10 kVAr	QHSTMD5010X0	Champion 480 V 50 Hz-10 kVAr 3 PH	12.03	3 X 46.0	1 N	1 N	5814.00
12.5 kVAr	QHSTMD5012X5	Champion 480 V 50 Hz-12.5 kVAr 3 PH	15.04	3 X 57.6	1 N	1 N	7268.00
15 kVAr	QHSTMD5015X0	Champion 480 V 50 Hz-15 kVAr 3 PH	18.04	6 X 34.5	1 N	1 N	8721.00
20 kVAr	QHSTMD5020X0	Champion 480 V 50 Hz-20 kVAr 3 PH	24.06	6 X 46.0	1 N	1 N	11629.00
25 kVAr	QHSTMD5025X0	Champion 480 V 50 Hz-25 kVAr 3 PH	30.07	6 X 57.6	1 N	1 N	14535.00
30 kVAr	QHSTMD5030X0	Champion 480 V 50 Hz-30 kVAr 3 PH	36.09	12 X 34.5	1 N	1 N	17830.00
50 kVAr	QHSTMD5050X0	Champion 480 V 50 Hz-50 kVAr 3 PH	60.14	12 X 57.6	1 N	1 N	29717.00
60 kVAr	QHSTMD5060X0	Champion 480 V 50 Hz-60 kVAr 3 PH	72.18	18 X 46.0	1 N	1 N	35660.00
Rated Voltage 525 Vac, 3ø, 50 Hz, Delta Connection							
5 kVAr	QHSTMF5005X0	Champion 525 V 50 Hz-5 kVAr 3 PH	5.50	3 X 19.2	1 N	1 N	3004.00
6 kVAr	QHSTMF5006X0	Champion 525 V 50 Hz-6 kVAr 3 PH	6.60	3 X 23.1	1 N	1 N	3605.00
7.5 kVAr	QHSTMF5007X5	Champion 525 V 50 Hz-7.5 kVAr 3 PH	8.25	3 X 28.9	1 N	1 N	4506.00
10 kVAr	QHSTMF5010X0	Champion 525 V 50 Hz-10 kVAr 3 PH	11.00	3 X 38.5	1 N	1 N	6008.00
12.5 kVAr	QHSTMF5012X5	Champion 525 V 50 Hz-12.5 kVAr 3 PH	13.75	3 X 48.1	1 N	1 N	7510.00
15 kVAr	QHSTMF5015X0	Champion 525 V 50 Hz-15 kVAr 3 PH	16.50	6 X 28.9	1 N	1 N	9012.00
20 kVAr	QHSTMF5020X0	Champion 525 V 50 Hz-20 kVAr 3 PH	21.99	6 X 38.5	1 N	1 N	12016.00
25 kVAr	QHSTMF5025X0	Champion 525 V 50 Hz-25 kVAr 3 PH	27.49	6 X 48.1	1 N	1 N	15020.00
30 kVAr	QHSTMF5030X0	Champion 525 V 50 Hz-30 kVAr 3 PH	33.00	12 X 28.9	1 N	1 N	18488.00
50 kVAr	QHSTMF5050X0	Champion 525 V 50 Hz-50 kVAr 3 PH	54.99	12 X 48.1	1 N	1 N	30814.00
60 kVAr	QHSTMF5060X0	Champion 525 V 50 Hz-60 kVAr 3 PH	66.00	18 X 38.5	1 N	1 N	36978.00



Hercules - Normal Duty Single Phase Cylindrical Capacitors

HSN Code: 8532

(IS: 13340)

Rating kVAr	Item Code	Description	I _r A	C μF	Standard Pack No of unit/s	Master Pack No of unit/s	Per Unit LP (₹)
Rated Voltage 250 Vac, 1ø, 50 Hz							
1 kVAr	QHNSCS5001X0	HERCULES 250 V 50 Hz-1 kVAr 1 PH	4.00 A	50.92	1 N	16 N	332.00
2 kVAr	QHNSCS5002X0	HERCULES 250 V 50 Hz-2 kVAr 1 PH	8.00 A	101.84	1 N	16 N	546.00
3 kVAr	QHNSCS5003X0	HERCULES 250 V 50 Hz-3 kVAr 1 PH	12.00 A	152.76	1 N	16 N	823.00
4 kVAr	QHNSCS5004X0	HERCULES 250 V 50 Hz-4 kVAr 1 PH	16.00 A	203.68	1 N	16 N	1099.00
5 kVAr	QHNSCS5005X0	HERCULES 250 V 50 Hz-5 kVAr 1 PH	16.00 A	254.61	1 N	16 N	1376.00
Rated Voltage 415 Vac, 1ø, 50 Hz							
1 kVAr	QHNSCB5001X0	HERCULES 415 V 50 Hz-1 kVAr 1 PH	2.41 A	18.48	1 N	16 N	332.00
2 kVAr	QHNSCB5002X0	HERCULES 415 V 50 Hz-2 kVAr 1 PH	4.62 A	36.96	1 N	16 N	546.00
3 kVAr	QHNSCB5003X0	HERCULES 415 V 50 Hz-3 kVAr 1 PH	7.23 A	55.44	1 N	16 N	823.00
4 kVAr	QHNSCB5004X0	HERCULES 415 V 50 Hz-4 kVAr 1 PH	9.64 A	73.92	1 N	16 N	1099.00
5 kVAr	QHNSCB5005X0	HERCULES 415 V 50 Hz-5 kVAr 1 PH	12.05 A	92.40	1 N	16 N	1376.00
7.5 kVAr	QHNSCB5007X5	HERCULES 415 V 50 Hz-7.5 kVAr 1 PH	18.08 A	138.60	1 N	8 N	2060.00
10 kVAr	QHNSCB5010X0	HERCULES 415 V 50 Hz-10 kVAr 1 PH	24.10 A	184.80	1 N	8 N	2745.00



Thyristor Switch

Cat. Code	Description	Per Unit LP (₹)
QHZCF00111	Thyristor Switch 15 kVAr	25465.00
QHZCF00121	Thyristor Switch 25 kVAr	29333.00
QHZCF00131	Thyristor Switch 50 kVAr	36000.00
QHZCF00141	Thyristor Switch 100 kVAr	52000.00

Note: For fast Switching Load

HD Harmonic Detuned Reactor

In a practical network, XL is contributed by the transformers and line inductances and XC is contributed by the PF capacitors. Hence for any industry with power factor correction capacitors installed, there is a possibility of resonance, due to one of the following reasons:

- Parallel resonance within a given electrical system, involving internally generated harmonics and resonance between local capacitors and the predominantly inductive supply (transformers)
- Series resonance between external harmonics (in the supply system and capacitors within electrical system)
- Interactive resonance between different harmonics filters within a given electrical network.

Addition of detuned reactors (in series to capacitors) forcefully shifts the resonant frequency to a safer level. For example, combination of capacitor and 7% detuned filter reactor has the resonance frequency of 189 Hz, which will avoid resonance with 5th harmonic and above.

Range:

- Effective Reactor output 1 kVAr to 100 kVAr
- Available in: Copper & Aluminium
- Detuning Factor: 5.67%, 7% and 14% corresponding to tuning Frequencies of 210 Hz, 189 Hz and 133 Hz for the base of 50 Hz
- Rated Voltage: 200 V, 440 V, 690 V, 800 V
- linearity : 185% to 225% of In

Features:

- High linearity 185% to 225%
- Insulation Class H
- High harmonic loading capability
- Temperature protection - NC contact (UL Approved)
- Long expected life time
- Low noise & very low losses
- IEC 61558



Selection Chart: Capacitor voltage and kVAr selection for 5.67%, 7% and 14% reactors

Effective kVAr output	With 5.67% detuned reactor		With 7% detuned reactor		With 14% detuned reactor	
	Reactor (440V)	Capacitor (480V)**	Reactor (440V)	Capacitor (480V)**	Reactor (440V)	Capacitor (525V)**
5kVAr	5 kVAr	6kVAr/480V	5 kVAr	6kVAr/480V	5 kVAr	6kVAr/525V
10kVAr	10 kVAr	12.5kVAr/480V	10 kVAr	12.5kVAr/480V	10 kVAr	12.5kVAr/525V
12.5kVAr	12.5 kVAr	15kVAr/480V	12.5 kVAr	15kVAr/480V	12.5 kVAr	15kVAr/525V
15kVAr	15 kVAr	20kVAr/480V	15 kVAr	20kVAr/480V	15 kVAr	20kVAr/525V
20kVAr	20 kVAr	25kVAr/480V	20 kVAr	25kVAr/480V	20 kVAr	25kVAr/525V
25kVAr	25 kVAr	30kVAr/480V	25 kVAr	30kVAr/480V	25 kVAr	30kVAr/525V
50kVAr	50 kVAr	60kVAr/480V	50 kVAr	60kVAr/480V	50 kVAr	60kVAr/525V

HD Harmonic Detuned Reactor - 7%

Rating kVAr	Cat. Code	Description	Per Unit LP (₹)
Rated Voltage 440 Vac, F = 50 Hz, P = 7% (Fr = 189 Hz) / Linearity: L > 0.95 Lr for current up to 1.85 . I1 (Aluminium)			
1 kVAr	QHCLTCV001X0	H. D.- REACTOR, 7% AL, 01 kVAr 440 Vac	3779.00
2 kVAr	QHCLTCV002X0	H. D.- REACTOR, 7% AL, 02 kVAr 440 Vac	4714.00
3 kVAr	QHCLTCV003X0	H. D.- REACTOR, 7% AL, 03 kVAr 440 Vac	5650.00
4 kVAr	QHCLTCV004X0	H. D.- REACTOR, 7% AL, 04 kVAr 440 Vac	6002.00
5 kVAr	QHCLTCV005X0	H. D.- REACTOR, 7% AL, 05 kVAr 440 Vac	6452.00
10 kVAr	QHCLTCV010X0	H. D.- REACTOR, 7% AL, 10 kVAr 440 Vac	9159.00
12.5 kVAr	QHCLTCV012X5	H. D.- REACTOR, 7% AL, 12.5 kVAr 440 Vac	10048.00
15 kVAr	QHCLTCV015X0	H. D.- REACTOR, 7% AL, 15 kVAr 440 Vac	10749.00
20 kVAr	QHCLTCV020X0	H. D.- REACTOR, 7% AL, 20 kVAr 440 Vac	12808.00
25 kVAr	QHCLTCV025X0	H. D.- REACTOR, 7% AL, 25 kVAr 440 Vac	13554.00
50 kVAr	QHCLTCV050X0	H. D.- REACTOR, 7% AL, 50 kVAr 440 Vac	23766.00
75 kVAr	QHCLTCV075X0	H. D.- REACTOR, 7% AL, 75 kVAr 440 Vac	31805.00
100 kVAr	QHCLTCV100X0	H. D.- REACTOR, 7% AL, 100 kVAr 440 Vac	40793.00
Rated Voltage 440 Vac, F = 50 Hz, P = 7% (Fr = 189 Hz) / Linearity: L > 0.95 Lr for current up to 1.85 . I1 (Copper)			
1 kVAr	QHCTLCV001X0	H. D.- REACTOR, 7% CU, 01 kVAr 440 Vac	4802.00
2 kVAr	QHCTLCV002X0	H. D.- REACTOR, 7% CU, 02 kVAr 440 Vac	5420.00
3 kVAr	QHCTLCV003X0	H. D.- REACTOR, 7% CU, 03 kVAr 440 Vac	6201.00
4 kVAr	QHCTLCV004X0	H. D.- REACTOR, 7% CU, 04 kVAr 440 Vac	7320.00
5 kVAr	QHCTLCV005X0	H. D.- REACTOR, 7% CU, 05 kVAr 440 Vac	8050.00
10 kVAr	QHCTLCV010X0	H. D.- REACTOR, 7% CU, 10 kVAr 440 Vac	12656.00
12.5 kVAr	QHCTLCV012X5	H. D.- REACTOR, 7% CU, 12.5 kVAr 440 Vac	14028.00
15 kVAr	QHCTLCV015X0	H. D.- REACTOR, 7% CU, 15 kVAr 440 Vac	15536.00
20 kVAr	QHCTLCV020X0	H. D.- REACTOR, 7% CU, 20 kVAr 440 Vac	18400.00
25 kVAr	QHCTLCV025X0	H. D.- REACTOR, 7% CU, 25 kVAr 440 Vac	19561.00
50 kVAr	QHCTLCV050X0	H. D.- REACTOR, 7% CU, 50 kVAr 440 Vac	32148.00
75 kVAr	QHCTLCV075X0	H. D.- REACTOR, 7% CU, 75 kVAr 440 Vac	46811.00
100 kVAr	QHCTLCV100X0	H. D.- REACTOR, 7% CU, 100 kVAr 440 Vac	66012.00

HD Harmonic Detuned Reactor - 14%

Rating kVAr	Cat. Code	Description	Per Unit LP (₹)
Rated Voltage 440 Vac, F = 50 Hz, P = 7% (Fr = 189 Hz) / Linearity: L > 0.95 Lr for current up to 1.85 . I1			
5 kVAr	QHCTLCV005X0S	H. D.- REACTOR, 14% , 05 kVAr	9404.00
10 kVAr	QHCTLCV010X0S	H. D.- REACTOR, 14% , 10 kVAr	14785.00
12.5 kVAr	QHCTLCV012X5S	H. D.- REACTOR, 14% , 12.5 kVAr	16388.00
15 kVAr	QHCTLCV015X0S	H. D.- REACTOR, 14% , 15 kVAr	18150.00
20 kVAr	QHCTLCV020X0S	H. D.- REACTOR, 14% , 20 kVAr	21495.00
25 kVAr	QHCTLCV025X0S	H. D.- REACTOR, 14% , 25 kVAr	22851.00
50 kVAr	QHCTLCV050X0S	H. D.- REACTOR, 14% , 50 kVAr	37556.00
75 kVAr	QHCTLCV075X0S	H. D.- REACTOR, 14% , 75 kVAr	54686.00
100 kVAr	QHCTLCV100X0S	H. D.- REACTOR, 14% , 100 kVAr	77116.00

Consulting, Optimizing & Delivering Performance

Power Solutions - Havells



Active Harmonic Filter and Load Balancer (NEW)

HSN Code: 8543



Rating in Ampere	Cat No.	Description	Per Unit LP (₹)
10 A		10 A / 415 AHF Panel	80000.00
20 A		20 A / 415 AHF Panel	160000.00
30 A		30 A / 415 AHF Panel	240000.00
50 A		50 A / 415 AHF Panel	400000.00
75 A		75 A / 415 AHF Panel	600000.00
100 A		100 A / 415 AHF Panel	800000.00
125 A		125 A / 415 AHF Panel	1000000.00
150 A		150 A / 415 AHF Panel	1200000.00
200 A		200 A / 415 AHF Panel	1600000.00
250 A		250 A / 415 AHF Panel	2000000.00
300 A		300 A / 415 AHF Panel	2400000.00
400 A		400 A / 415 AHF Panel	3200000.00
500 A		500 A / 415 AHF Panel	4000000.00



IEEE 519-2014 Guidelines for Harmonics Limits

Table 2 - Current distortion limits for systems rated 120 V through 69 kV

Maximum harmonic current distortion in percent of I_L						
Individual harmonic order (odd harmonics) ^{a, b}						
I_{sc}/I_L	$3 \leq h < 11$	$11 \leq h < 17$	$17 \leq h < 23$	$23 \leq h < 35$	$35 \leq h \leq 50$	TDD
<20	4.0	2.0	1.5	0.6	0.3	5.0
20<50	7.0	3.5	2.5	1.0	0.5	8.0
50<100	10.0	4.5	4.0	1.5	0.7	12.0
100<1000	12.0	5.5	5.0	2.0	1.0	15.0
>1000	15.0	7.0	6.0	2.5	1.4	20.0

AHF Technical

System Connection	3 P / 4 W or 4 P / 4 W
Input Voltage	415 V (+/-10%) and 50 Hz (+/-)5% other rating on request
Phase compensation current range	15 A - 1000 A (other ratings on request)
Technology	Two Level Topology / Three Level Topology
Harmonic filtration range	2nd to 51st order
Individual harmonic selection	Available
Power factor compensation	100% (Lead / Lag)
Load Balancing	Negative Sequence Compensation (Zero Sequence compensation in 4 P / 4 W range)
Neutral Current Compensation	Available
Reaction time	<0.3 ms
Interface (Communication)	GSM, MODBUS RTU, USB, Ethernet, Profibus Compatible
IP Protection Class	IP-41 and higher on request
System Cooling	Forced air colling
Overheating Protection	Yes
Relative Humidity	96% (Non condensing)
Ambient Temperature	No deration upto 500C

Hybrid PQ Manager

Range	Per Unit LP (₹)
10 kVAr to 3000 kVAr (Hybrid PQ Manager)	Price on request



HAVELLS

Agricultural Duty Capacitor



- Range: 1 kVAR to 15 kVAR
- Voltage: 415 V
- MPP SH, Resin filled
- Low watt loss

Note: For Agricultural use only.

Agri Boost - Normal Duty Cylindrical Capacitors for Agriculture Applications



HSN Code: 8532

(IS: 13340)

Rating kVAr	Item Code	Description	I _r A	C μF	Standard Pack No of unit/s	Master Pack No of unit/s	Per Unit LP (₹)
Rated Voltage 415 Vac, 3ø, 50 Hz, Delta Connection							
1 kVAr	QHATCB5001X0	AGRI BOOST ND 415 V 50 Hz-1 kVAr 3 PH	1.39 A	3 x 6.2	1 N	16 N	267.00
2 kVAr	QHATCB5002X0	AGRI BOOST ND 415 V 50 Hz-2 kVAr 3 PH	2.78 A	3 x 12.3	1 N	16 N	312.00
3 kVAr	QHATCB5003X0	AGRI BOOST ND 415 V 50 Hz-3 kVAr 3 PH	4.17 A	3 x 18.5	1 N	16 N	468.00
4 kVAr	QHATCB5004X0	AGRI BOOST ND 415 V 50 Hz-4 kVAr 3 PH	5.56 A	3 x 24.6	1 N	16 N	624.00
5 kVAr	QHATCB5005X0	AGRI BOOST ND 415 V 50 Hz-5 kVAr 3 PH	6.96 A	3 x 30.8	1 N	16 N	780.00
6 kVAr	QHATCB5006X0	AGRI BOOST ND 415 V 50 Hz-6 kVAr 3 PH	8.35 A	3 x 37.0	1 N	16 N	936.00
7.5 kVAr	QHATCB5007X5	AGRI BOOST ND 415 V 50 Hz-7.5 kVAr 3 PH	10.43 A	3 x 46.2	1 N	16 N	1170.00
8 kVAr	QHATCB5008X0	AGRI BOOST ND 415 V 50 Hz-8 kVAr 3 PH	11.13 A	3 x 49.3	1 N	16 N	1247.00
10 kVAr	QHATCB5010X0	AGRI BOOST ND 415 V 50 Hz-10 kVAr 3 PH	13.91 A	3 x 61.6	1 N	16 N	1559.00
12.5 kVAr	QHATCB5012X5	AGRI BOOST ND 415 V 50 Hz-12.5 kVAr 3 PH	17.39 A	3 x 77.0	1 N	8 N	1950.00
15 kVAr	QHATCB5015X0	AGRI BOOST ND 415 V 50 Hz-15 kVAr 3 PH	20.87 A	3 x 92.4	1 N	8 N	2339.00

Other Ratings on request



REGIONAL & BRANCH OFFICES:

NORTH - REGIONAL OFFICE: Corporate Office: QRG Towers, 2D, Sector-126, Expressway, Noida-201304, Tel: 0120-3331000, Delhi: 011-47676700, 23888200, Chandigarh: 0172-4232400-401, Dehradun: 0135-6670202, Haldwani: 05946-222935/222933, Noida / Haryana: 0120-3331000, Ludhiana: 0161-4676000/24, Amritsar: 0183-5202400/401, Jammu: 0191-2478330, 2479330, Sri Nagar: 0194-2459248, Jaipur: 0141-4211000, 4211011, Jodhpur: 9214201640/41, Lucknow: 0522- 4921600/4921649, Kanpur: 0512-6710400

EAST - REGIONAL OFFICE: Kolkata: ICC Tower, 5th Floor, 4 India Exchange Place, Kolkata-700001, Tel: 033-40129851/52, Bhubaneswar: 0674-6668101/102/103/104, Guwahati: 0361-2458923, 2134521, Siliguri: 0353-2525907, Ranchi: 0651-2244861, 2244862, 2244864, 2244868, 2244869, Jamshedpur: 0657-6542492, 09234369436, Patna: 0612-2207221, 2207222, 2207223, 2655518

WEST - REGIONAL OFFICE: 1271, Solitaire Corporate Park, Bldg. No. 12, 7th Floor, Andheri - Ghatkopar Link Road, Chakala, Andheri (East), Mumbai- 400093. Tel: 022 - 67298600-602, Ahmedabad: 079-40061111, 40060738/740, Indore: 0731-4219444/4219422, 0731-2572340, Rajkot: 0281-2481112, 2921212, Nagpur: 0712-2240932, 2242692, 2242699 Pune: 020-26056175-76, Raipur: 0771-4243400/01, Surat: 0261-2350137, 9979890137, Jabalpur: 0761-4064491, Bhopal: 0755-4271544, 0755-4011025,

SOUTH - REGIONAL OFFICE: Chennai: Sigapi Achi Building, No. 18 / 3, 6th Floor, Rukmani Lakshmiipathy Road, Egmore, Chennai-600008, Tel: 044-42280600, 605, Bangalore: 080-49075000, Coimbatore: 0422-4550200/282, Hyderabad: 040-27533372, 27533355, 27533632, Cochin: 0484-4099000, Calicut: 0495-4019193/4/5, Trivandrum: 0471-4015323, Vizag: 0891-6514339, Vijayawada: 0866-2546161/62/67/68/69, Madurai: 0452-4267000, Hubli: 0836-4248660, Trichy: 0431-4041005/06

Representative Offices: • Goa • Solapur • Gwalior • Kathmandu • Bhopal • Kolapur • Vadodara

Warranty Policy:

All the products listed in the price list carry a warranty, against manufacturing defects for a period of 18* months from the date of purchase / 12 months from the date of commissioning, whichever is earlier.

*Proof of purchase to be retained to avail warranty.

Terms & Conditions

- Prices are in Indian ₹.
- This Price List supersedes all our previous Price Lists.
- Prices are subject to change without notice.
- Company reserves the right to issue amendments, which may arise due to any errors in the price list.

Actual products may vary in colour, design, description and colour combination etc. Although every effort has been made to ensure accuracy in the compilation of the technical detail within this publication. Specifications & performance data are constantly changing.

"Copyright Subsists. Imitation of trade dress, graphics and color scheme of this document is a punishable offence."

Note: All Products to be billed at 18% *GST (Subject to change as per Govt. Notification).



Havells India Ltd.

Corp Office: QRG Towers, 2D, Sector-126, Expressway, Noida-201304 (U.P.)

Ph. +91-120-3331000, Email: marketing@havells.com, www.havells.com

Customer Care No.: 08045 77 1313

Join us on Facebook at www.facebook.com/havells and share your ways to save planet!

CIN - L31900DL1983PLC016304



HAVELLS